



PROFESS¹ONAL
SERIES

FATALTY
GAMING GEAR

ASRock

Z370 Gaming K6

User Manual

Version 1.1

Published August 2017

Copyright©2017 ASRock INC. All rights reserved.

Copyright Notice:

No part of this documentation may be reproduced, transcribed, transmitted, or translated in any language, in any form or by any means, except duplication of documentation by the purchaser for backup purpose, without written consent of ASRock Inc.

Products and corporate names appearing in this documentation may or may not be registered trademarks or copyrights of their respective companies, and are used only for identification or explanation and to the owners' benefit, without intent to infringe.

Disclaimer:

Specifications and information contained in this documentation are furnished for informational use only and subject to change without notice, and should not be constructed as a commitment by ASRock. ASRock assumes no responsibility for any errors or omissions that may appear in this documentation.

With respect to the contents of this documentation, ASRock does not provide warranty of any kind, either expressed or implied, including but not limited to the implied warranties or conditions of merchantability or fitness for a particular purpose.

In no event shall ASRock, its directors, officers, employees, or agents be liable for any indirect, special, incidental, or consequential damages (including damages for loss of profits, loss of business, loss of data, interruption of business and the like), even if ASRock has been advised of the possibility of such damages arising from any defect or error in the documentation or product.



This device complies with Part 15 of the FCC Rules. Operation is subject to the following two conditions:

- (1) this device may not cause harmful interference, and
- (2) this device must accept any interference received, including interference that may cause undesired operation.

CALIFORNIA, USA ONLY

The Lithium battery adopted on this motherboard contains Perchlorate, a toxic substance controlled in Perchlorate Best Management Practices (BMP) regulations passed by the California Legislature. When you discard the Lithium battery in California, USA, please follow the related regulations in advance.

“Perchlorate Material-special handling may apply, see www.dtsc.ca.gov/hazardouswaste/perchlorate”

ASRock Website: <http://www.asrock.com>

AUSTRALIA ONLY

Our goods come with guarantees that cannot be excluded under the Australian Consumer Law. You are entitled to a replacement or refund for a major failure and compensation for any other reasonably foreseeable loss or damage caused by our goods. You are also entitled to have the goods repaired or replaced if the goods fail to be of acceptable quality and the failure does not amount to a major failure. If you require assistance please call ASRock Tel : +886-2-28965588 ext.123 (Standard International call charges apply)

The terms HDMI™ and HDMI High-Definition Multimedia Interface, and the HDMI logo are trademarks or registered trademarks of HDMI Licensing LLC in the United States and other countries.





Fatal1ty Story

Who knew that at age 19, I would be a World Champion PC gamer. When I was 13, I actually played competitive billiards in professional tournaments and won four or five games off guys who played at the highest level. I actually thought of making a career of it, but at that young age situations change rapidly. Because I've been blessed with great hand-eye coordination and a grasp of mathematics (an important element in video gaming) I gravitated to that activity.

GOING PRO

I started professional gaming in 1999 when I entered the CPL (Cyberathlete Professional League) tournament in Dallas and won \$4,000 for coming in third place. Emerging as one of the top players in the United States, a company interested in sponsoring me flew me to Sweden to compete against the top 12 players in the world. I won 18 straight games, lost none, and took first place, becoming the number one ranked Quake III player in the world in the process. Two months later I followed that success by traveling to Dallas and defending my title as the world's best Quake III player, winning the \$40,000 grand prize. From there I entered competitions all over the world, including Singapore, Korea, Germany, Australia, Holland and Brazil in addition to Los Angeles, New York and St. Louis.

WINNING STREAK

I was excited to showcase my true gaming skills when defending my title as CPL Champion of the year at the CPL Winter 2001 because I would be competing in a totally different first person shooter (fps) game, Alien vs. Predator II. I won that competition and walked away with a new car. The next year I won the same title playing Unreal Tournament 2003, becoming the only three-time CPL champion of the year. And I did it playing a different game each year, something no one else has ever done and a feat of which I am extremely proud.

At QuakeCon 2002, I faced off against my rival ZeRo4 in one of the most highly anticipated matches of the year, winning in a 14 to (-1) killer victory. Competing at Quakecon 2004, I became the World's 1st Doom3 Champion by defeating Daler in a series of very challenging matches and earning \$25,000 for the victory.

Since then Fatal1ty has traveled the globe to compete against the best in the world, winning prizes and acclaim, including the 2005 CPL World Tour Championship in New York City for a \$150,000 first place triumph. In August 2007, Johnathan was awarded the first ever Lifetime Achievement Award in the four year history of the eSports-Award for "showing exceptional sportsmanship, taking part in shaping eSports into what it is today and for being the prime representative of this young sport. He has become the figurehead for eSports worldwide".

LIVIN' LARGE

Since my first big tournament wins, I have been a "Professional Cyberathlete", traveling the world and livin' large with lots of International media coverage on outlets such as MTV, ESPN and a 60 Minutes segment on CBS to name only a few. It's unreal - it's crazy. I'm living a dream by playing video games for a living. I've always been athletic and took sports like hockey and football very seriously, working out and training hard. This discipline helps me become a better gamer and my drive to be the best has opened the doors necessary to become a professional.

A DREAM

Now, another dream is being realized – building the ultimate gaming computer, made up of the best parts under my own brand. Quality hardware makes a huge difference in competitions...a couple more frames per second and everything gets really nice. It's all about getting the computer processing faster and allowing more fluid movement around the maps.

My vision for Fatal1ty hardware is to allow gamers to focus on the game without worrying about their equipment, something I've preached since I began competing. I don't want to worry about my equipment. I want to be there – over and done with - so I can focus on the game. I want it to be the fastest and most stable computer equipment on the face of the planet, so quality is what Fatal1ty Brand products represent.



Johnathan "Fatal1ty" Wendel



Contents

Chapter 1 Introduction	1
1.1 Package Contents	1
1.2 Specifications	2
1.3 Motherboard Layout	8
1.4 I/O Panel	10
Chapter 2 Installation	12
2.1 Installing the CPU	13
2.2 Installing the CPU Fan and Heatsink	16
2.3 Installing Memory Modules (DIMM)	17
2.4 Expansion Slots (PCI Express Slots)	19
2.5 Jumpers Setup	20
2.6 Onboard Headers and Connectors	21
2.7 Smart Switches	26
2.8 Dr. Debug	27
2.9 SLI™ and Quad SLI™ Operation Guide	29
2.9.1 Installing Two SLI™-Ready Graphics Cards	29
2.9.2 Driver Installation and Setup	31
2.10 CrossFireX™, 3-Way CrossFireX™ and Quad CrossFireX™ Operation Guide	32
2.10.1 Installing Two CrossFireX™-Ready Graphics Cards	32
2.10.2 Installing Three CrossFireX™-Ready Graphics Cards	34
2.10.3 Driver Installation and Setup	35
2.11 M.2 WiFi/BT Module Installation Guide (M2_3)	36

2.12	M.2_SSD (NGFF) Module Installation Guide (M2_1 and M2_2)	38
------	--	----

Chapter 3 Software and Utilities Operation 42

3.1	Installing Drivers	42
3.2	F-Stream	43
3.2.1	Installing F-Stream	43
3.2.2	Using F-Stream	43
3.3	ASRock Live Update & APP Shop	46
3.3.1	UI Overview	46
3.3.2	Apps	47
3.3.3	BIOS & Drivers	50
3.3.4	Setting	51
3.4	Creative SoundBlaster Cinema3	52
3.5	ASRock RGB LED	53

Chapter 4 UEFI SETUP UTILITY 55

4.1	Introduction	55
4.2	EZ Mode	56
4.3	Advanced Mode	57
4.3.1	UEFI Menu Bar	57
4.3.2	Navigation Keys	58
4.4	Main Screen	59
4.5	OC Tweaker Screen	60
4.6	Advanced Screen	71
4.6.1	CPU Configuration	72

4.6.2	Chipset Configuration	74
4.6.3	Storage Configuration	77
4.6.4	Intel® Thunderbolt	79
4.6.5	Super IO Configuration	80
4.6.6	ACPI Configuration	81
4.6.7	USB Configuration	83
4.6.8	Trusted Computing	84
4.7	Tools	85
4.8	Hardware Health Event Monitoring Screen	88
4.9	Security Screen	91
4.10	Boot Screen	92
4.11	Exit Screen	95

Chapter 1 Introduction

Thank you for purchasing ASRock Fatal1ty Z370 Gaming K6 Series motherboard, a reliable motherboard produced under ASRock's consistently stringent quality control. It delivers excellent performance with robust design conforming to ASRock's commitment to quality and endurance.

In this documentation, Chapter 1 and 2 contains the introduction of the motherboard and step-by-step installation guides. Chapter 3 contains the operation guide of the software and utilities. Chapter 4 contains the configuration guide of the BIOS setup.



Because the motherboard specifications and the BIOS software might be updated, the content of this documentation will be subject to change without notice. In case any modifications of this documentation occur, the updated version will be available on ASRock's website without further notice. If you require technical support related to this motherboard, please visit our website for specific information about the model you are using. You may find the latest VGA cards and CPU support list on ASRock's website as well. ASRock website <http://www.asrock.com>.

1.1 Package Contents

- ASRock Fatal1ty Z370 Gaming K6 Series Motherboard (ATX Form Factor)
- ASRock Fatal1ty Z370 Gaming K6 Series Quick Installation Guide
- ASRock Fatal1ty Z370 Gaming K6 Series Support CD
- 1 x I/O Panel Shield
- 4 x Serial ATA (SATA) Data Cables (Optional)
- 1 x ASRock SLI_HB_Bridge_2S Card (Optional)
- 3 x Screws for M.2 Socket (Optional)

1.2 Specifications

Platform • ATX Form Factor

CPU

- Supports 8th Generation Intel® Core™ Processors (Socket 1151)
- Digi Power design
- 12 Power Phase design
- Supports Intel® Turbo Boost 2.0 Technology
- Supports Intel® K-Series unlocked CPUs
- Supports ASRock BCLK Full-range Overclocking
- Supports ASRock Hyper BCLK Engine II

Chipset • Intel® Z370

Memory

- Dual Channel DDR4 Memory Technology
- 4 x DDR4 DIMM Slots
- Supports DDR4 4333+(OC)*/4000(OC)/3866(OC)/3800(OC)/3733(OC)/3600(OC)/3200(OC)/2933(OC)/2800(OC)/2666/2400/2133 non-ECC, un-buffered memory

* Please refer to Memory Support List on ASRock's website for more information. (<http://www.asrock.com/>)

* 8th Gen Intel® CPU supports DDR4 up to 2666.

- Supports ECC UDIMM memory modules (operate in non-ECC mode)
- Max. capacity of system memory: 64GB
- Supports Intel® Extreme Memory Profile (XMP) 2.0
- 15μ Gold Contact in DIMM Slots

Expansion Slot

- 3 x PCI Express 3.0 x16 Slots (PCIe2/PCIe4/PCIe6: single at x16 (PCIe2); dual at x8 (PCIe2) / x8 (PCIe4); triple at x8 (PCIe2) / x8 (PCIe4) / x4 (PCIe6)*)

* Supports NVMe SSD as boot disks

- 3 x PCI Express 3.0 x1 Slots (Flexible PCIe)
- Supports AMD Quad CrossFireX™, 3-Way CrossFireX™ and CrossFireX™
- Supports NVIDIA® Quad SLI™ and SLI™
- 1 x M.2 Socket (Key E), supports type 2230 WiFi/BT module
- 15μ Gold Contact in VGA PCIe Slot (PCIe2)

Graphics

- Intel® UHD Graphics Built-in Visuals and the VGA outputs can be supported only with processors which are GPU integrated.
- Supports Intel® UHD Graphics Built-in Visuals : Intel® Quick Sync Video with AVC, MVC (S3D) and MPEG-2 Full HW Encode1, Intel® InTru™ 3D, Intel® Clear Video HD Technology, Intel® Insider™, Intel® UHD Graphics
- DirectX 12
- HWAEncode/Decode: VP9 8-bit, VP9 10-bit (Encode only), VP8, HEVC (MPEG-H Part2, h.265), AVC (MPEG4, h.264), MPEG2-Part2 (h.262), JPEG/MJPEG,VC-1
- Max. shared memory 1024MB

* The size of maximum shared memory may vary from different operating systems.

- Three graphics output options: D-Sub, DVI-D and HDMI
- Supports Triple Monitor
- Supports HDMI with max. resolution up to 4K x 2K (4096x2160) @ 30Hz
- Supports DVI-D with max. resolution up to 1920x1200 @ 60Hz
- Supports D-Sub with max. resolution up to 1920x1200 @ 60Hz
- Supports Auto Lip Sync, Deep Color (12bpc), xvYCC and HBR (High Bit Rate Audio) with HDMI Port (Compliant HDMI monitor is required)
- Supports HDCP with DVI-D and HDMI Ports
- Supports 4K Ultra HD (UHD) playback with HDMI Ports

Audio

- 7.1 CH HD Audio with Content Protection (Realtek ALC1220 Audio Codec)
- Premium Blu-ray Audio support
- Supports Surge Protection
- Nichicon Fine Gold Series Audio Caps
- 120dB SNR DAC with Differential Amplifier
- NE5532 Premium Headset Amplifier for Front Panel Audio Connector (Supports up to 600 Ohm headsets)
- Pure Power-In

- Direct Drive Technology
- PCB Isolate Shielding
- Impedance Sensing on Front Out port
- Individual PCB Layers for R/L Audio Channel
- RGB LED
- Gold Audio Jacks
- 15µ Gold Audio Connector
- Supports Creative SoundBlaster Cinema3

LAN

- Gigabit LAN 10/100/1000 Mb/s
- 1 x Giga PHY Intel® I219V, 1 x GigaLAN Intel® I211AT
- Supports Wake-On-LAN
- Supports Lightning/ESD Protection
- Supports Energy Efficient Ethernet 802.3az
- Supports PXE

Rear Panel I/O

- 2 x Antenna Ports
- 1 x PS/2 Mouse/Keyboard Port
- 1 x D-Sub Port
- 1 x DVI-D Port
- 1 x HDMI Port
- 1 x Optical SPDIF Out Port
- 1 x USB 3.1 Gen2 Type-A Port (10 Gb/s) (ASMedia ASM3142) (Supports ESD Protection)
- 1 x USB 3.1 Gen2 Type-C Port (10 Gb/s) (ASMedia ASM3142) (Supports ESD Protection)
- 4 x USB 3.1 Gen1 Ports (Intel® Z370) (Supports ESD Protection)
- * 1 x FatalIty Mouse Port (USB 3.1 Gen1) is included
- * Ultra USB Power is supported on USB3_34 ports.
- * ACPI wake-up function is not supported on USB3_34 ports.
- 2 x RJ-45 LAN Ports with LED (ACT/LINK LED and SPEED LED)
- HD Audio Jacks: Rear Speaker / Central / Bass / Line in / Front Speaker / Microphone (Gold Audio Jacks)

Storage

- 6 x SATA3 6.0 Gb/s Connectors, support RAID (RAID 0, RAID 1, RAID 5, RAID 10, Intel Rapid Storage Technology 15), NCQ, AHCI and Hot Plug*
- 2 x SATA3 6.0 Gb/s Connectors by ASMedia ASM1061, support NCQ, AHCI and Hot Plug

* M2_1, SATA3_0 and SATA3_1 share lanes. If either one of them is in use, the others will be disabled.

* M2_2, SATA3_4 and SATA3_5 share lanes. If either one of them is in use, the others will be disabled.

- 1 x Ultra M.2 Socket (M2_1), supports M Key type 2230/2242/2260/2280 M.2 SATA3 6.0 Gb/s module and M.2 PCI Express module up to Gen3 x4 (32 Gb/s)**
- 1 x Ultra M.2 Socket (M2_2), supports M Key type 2230/2242/2260/2280/22110 M.2 SATA3 6.0 Gb/s module and M.2 PCI Express module up to Gen3 x4 (32 Gb/s)**

** Supports Intel® Optane™ Technology

** Supports NVMe SSD as boot disks

** Supports ASRock U.2 Kit

Connector

- 1 x COM Port Header
- 1 x TPM Header
- 1 x Power LED and Speaker Header
- 1 x RGB LED Header

* Supports in total up to 12V/3A, 36W LED Strip

- 1 x CPU Fan Connector (4-pin)

* The CPU Fan Connector supports the CPU fan of maximum 1A (12W) fan power.

- 1 x CPU Optional/Water Pump Fan Connector (4-pin)

* The CPU Optional/Water Pump Fan supports the water cooler fan of maximum 1.5A (18W) fan power.

- 2 x Chassis Fan Connectors (4-pin) (Smart Fan Speed Control)

- 1 x Chassis Optional/Water Pump Fan Connector (4-pin)

* The Chassis Optional/Water Pump Fan supports the water cooler fan of maximum 1.5A (18W) fan power.

* CHA_FAN1 and CHA_FAN2 can auto detect if 3-pin or 4-pin fan is in use.

- 1 x 24 pin ATX Power Connector (Hi-Density Power Connector)
- 1 x 8 pin 12V Power Connector (Hi-Density Power Connector)
- 1 x Front Panel Audio Connector (15µ Gold Audio Connector)
- 1 x Thunderbolt AIC Connector (5-pin)
- 3 x USB 2.0 Headers (Support 6 USB 2.0 ports) (Intel® Z370) (Supports ESD Protection)
- 1 x USB 3.1 Gen1 Header (Supports 2 USB 3.1 Gen1 ports) (Intel® Z370) (Supports ESD Protection)
- 1 x USB 3.1 Gen1 Header (Supports 2 USB 3.1 Gen1 ports) (ASMedia ASM1074 hub) (Supports ESD Protection)
- 1 x Front Panel Type C USB 3.1 Gen1 Header (ASMedia ASM1074 hub)
- 1 x Dr. Debug with LED
- 1 x Power Button with LED
- 1 x Reset Button with LED
- 1 x XMP Switch

BIOS Feature

- 2 x AMI UEFI Legal BIOS with multilingual GUI support (1 x Main BIOS and 1 x Backup BIOS)
- Supports Secure Backup UEFI Technology
- ACPI 6.0 Compliant wake up events
- SMBIOS 2.7 Support
- CPU Core/Cache, GT Core/Cache, DRAM, PCH 1.0V, VCCIO, VCCST, VCCSA, VCCPLL, CPU Internal PLL, GT PLL, Ring PLL, System Agent PLL, Memory Controller PLL Voltage Multi-adjustment

Hardware Monitor

- Temperature Sensing: CPU, CPU Optional/Water Pump, Chassis, Chassis Optional/Water Pump Fans
- Fan Tachometer: CPU, CPU Optional/Water Pump, Chassis, Chassis Optional/Water Pump Fans
- Quiet Fan (Auto adjust chassis fan speed by CPU temperature): CPU, CPU Optional/Water Pump, Chassis, Chassis Optional/Water Pump Fans

- Fan Multi-Speed Control: CPU, CPU Optional/Water Pump, Chassis, Chassis Optional/Water Pump Fans
- Voltage monitoring: +12V, +5V, +3.3V, CPU Vcore, DRAM, VPPM, PCH 1.0V, VCCSA, VCCST

OS

- Microsoft® Windows® 10 64-bit

**Certifica-
tions**

- FCC, CE
- ErP/EuP ready (ErP/EuP ready power supply is required)

* For detailed product information, please visit our website: <http://www.asrock.com>



Please realize that there is a certain risk involved with overclocking, including adjusting the setting in the BIOS, applying Untied Overclocking Technology, or using third-party overclocking tools. Overclocking may affect your system's stability, or even cause damage to the components and devices of your system. It should be done at your own risk and expense. We are not responsible for possible damage caused by overclocking.

1.3 Motherboard Layout

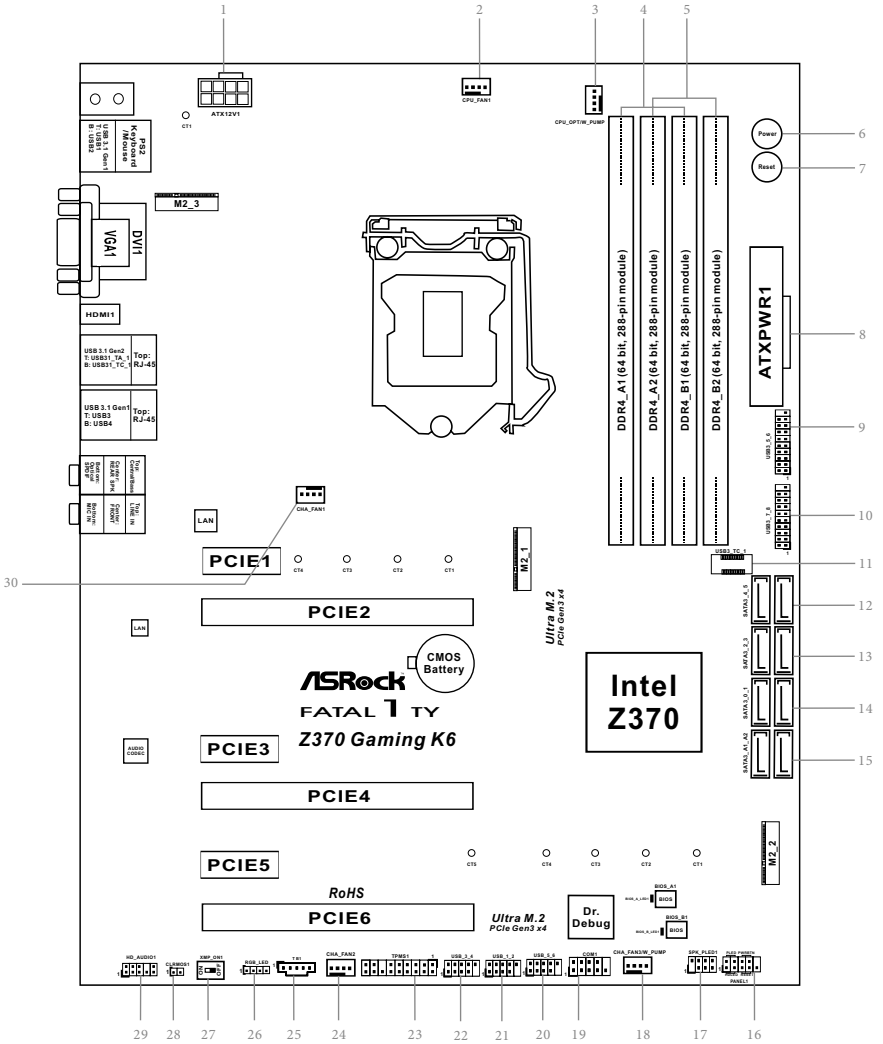

No.	Description
1	ATX 12V Power Connector (ATX12V1)
2	CPU Fan Connector (CPU_FAN1)
3	CPU Fan / Waterpump Fan Connector (CPU_OPT/W_PUMP)
4	2 x 288-pin DDR4 DIMM Slots (DDR4_A1, DDR4_B1)
5	2 x 288-pin DDR4 DIMM Slots (DDR4_A2, DDR4_B2)
6	Power Button (PWRBTN1)
7	Reset Button (RSTBTN1)
8	ATX Power Connector (ATXPWR1)
9	USB 3.1 Gen1 Header (USB3_5_6)
10	USB 3.1 Gen1 Header (USB3_7_8)
11	Front Panel Type C USB 3.1 Gen1 Header (USB3_TC_1)
12	SATA3 Connectors (SATA3_4_5)
13	SATA3 Connectors (SATA3_2_3)
14	SATA3 Connectors (SATA3_0_1)
15	SATA3 Connectors (SATA3_A1_A2)
16	System Panel Header (PANEL1)
17	Power LED and Speaker Header (SPK_PLED1)
18	Chassis Fan / Waterpump Fan Connector (CHA_FAN3/W_PUMP)
19	COM Port Header (COM1)
20	USB 2.0 Header (USB_5_6)
21	USB 2.0 Header (USB_1_2)
22	USB 2.0 Header (USB_3_4)
23	TPM Header (TPMS1)
24	Chassis Fan Connector (CHA_FAN2)
25	Thunderbolt AIC Connector (TB1)
26	RGB LED Header (RGB_LED)
27	XMP Switch (XMP_ON1)
28	Clear CMOS Jumper (CLRMOS1)
29	Front Panel Audio Header (HD_AUDIO1)
30	Chassis Fan Connector (CHA_FAN1)

1.4 I/O Panel

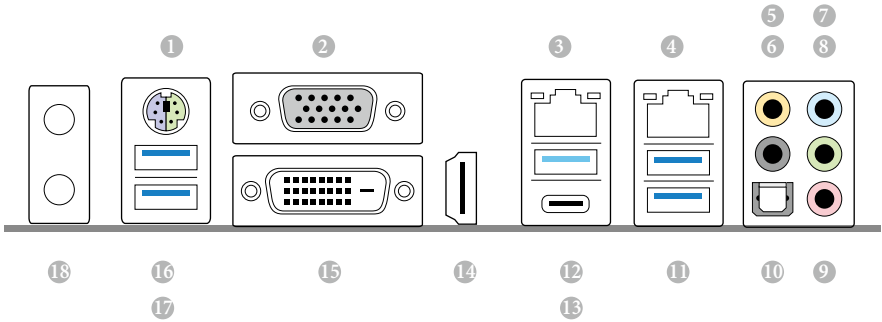

No.	Description	No.	Description
1	PS/2 Mouse/Keyboard Port (PS2_KB1)	10	Optical SPDIF Out Port
2	D-Sub Port	11	USB 3.1 Gen1 Ports (USB3_34)***
3	LAN RJ-45 Port (Intel* I211AT)*	12	USB 3.1 Gen2 Type-A Port (USB31_TA_1)
4	LAN RJ-45 Port (Intel* I219V)*	13	USB 3.1 Gen2 Type-C Port (USB31_TC_1)
5	Central / Bass (Orange)	14	HDMI Port
6	Rear Speaker (Black)	15	DVI-D Port
7	Line In (Light Blue)	16	FatalItty Mouse Port (USB3_1)
8	Front Speaker (Lime)**	17	USB 3.1 Gen1 Port (USB3_2)
9	Microphone (Pink)	18	Antenna Ports

* There are two LEDs on each LAN port. Please refer to the table below for the LAN port LED indications.

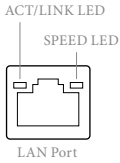

Activity / Link LED		Speed LED	
Status	Description	Status	Description
Off	No Link	Off	10Mbps connection
Blinking	Data Activity	Orange	100Mbps connection
On	Link	Green	1Gbps connection

** If you use a 2-channel speaker, please connect the speaker's plug into "Front Speaker Jack". See the table below for connection details in accordance with the type of speaker you use.

Audio Output Channels	Front Speaker (No. 8)	Rear Speaker (No. 6)	Central / Bass (No. 5)	Line In (No. 7)
2	V	--	--	--
4	V	V	--	--
6	V	V	V	--
8	V	V	V	V



To enable Multi-Streaming, you need to connect a front panel audio cable to the front panel audio header. After restarting your computer, you will find the "Mixer" tool on your system. Please select "Mixer ToolBox" , click "Enable playback multi-streaming", and click "ok". Choose "2CH", "4CH", "6CH", or "8CH" and then you are allowed to select "Realtek HDA Primary output" to use the Rear Speaker, Central/Bass, and Front Speaker, or select "Realtek HDA Audio 2nd output" to use the front panel audio.

*** ACPI wake-up function is not supported on USB3_34 ports.

Chapter 2 Installation

This is an ATX form factor motherboard. Before you install the motherboard, study the configuration of your chassis to ensure that the motherboard fits into it.

Pre-installation Precautions

Take note of the following precautions before you install motherboard components or change any motherboard settings.

- Make sure to unplug the power cord before installing or removing the motherboard components. Failure to do so may cause physical injuries and damages to motherboard components.
- In order to avoid damage from static electricity to the motherboard's components, NEVER place your motherboard directly on a carpet. Also remember to use a grounded wrist strap or touch a safety grounded object before you handle the components.
- Hold components by the edges and do not touch the ICs.
- Whenever you uninstall any components, place them on a grounded anti-static pad or in the bag that comes with the components.
- When placing screws to secure the motherboard to the chassis, please do not over-tighten the screws! Doing so may damage the motherboard.

2.1 Installing the CPU

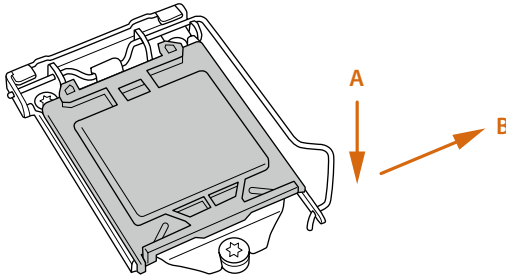
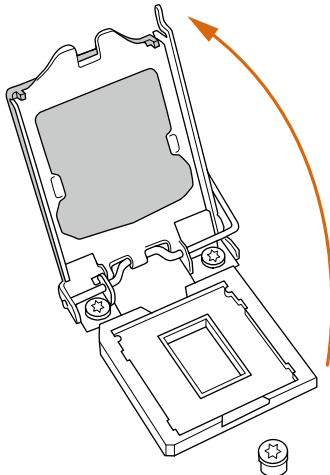

1. Before you insert the 1151-Pin CPU into the socket, please check if the **PnP cap** is on the socket, if the CPU surface is unclean, or if there are any **bent pins** in the socket. Do not force to insert the CPU into the socket if above situation is found. Otherwise, the CPU will be seriously damaged.
2. Unplug all power cables before installing the CPU.

1**2**

3

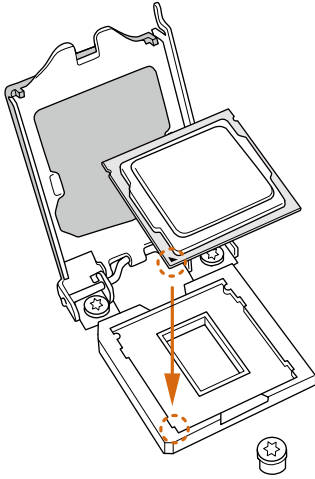

4

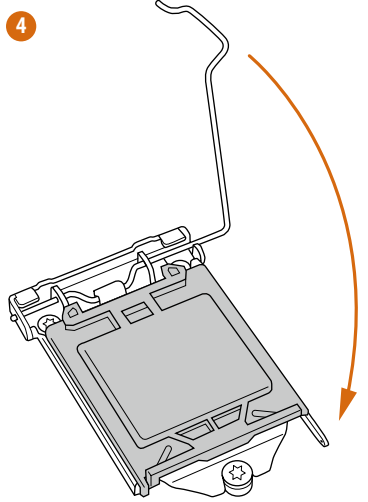

5

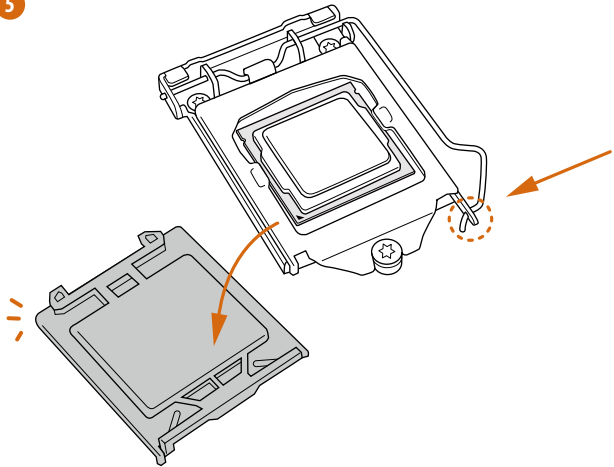



Please save and replace the cover if the processor is removed. The cover must be placed if you wish to return the motherboard for after service.

2.2 Installing the CPU Fan and Heatsink

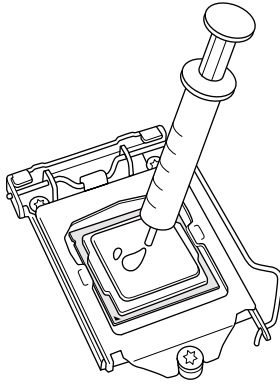

1

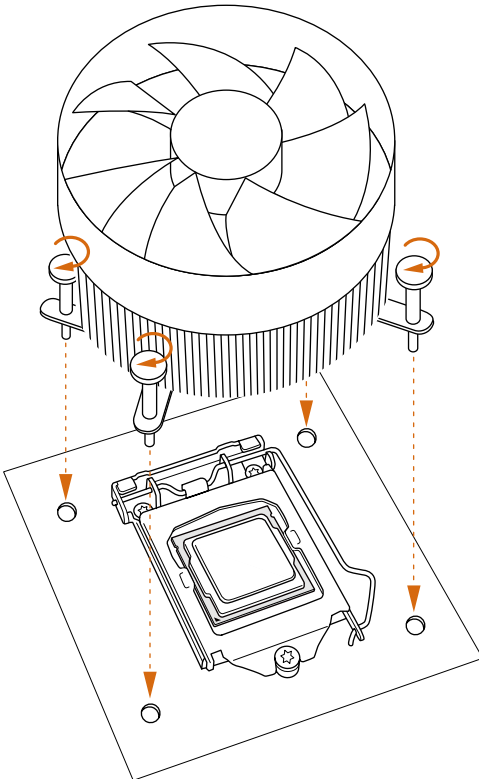

2

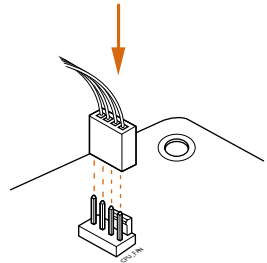

2.3 Installing Memory Modules (DIMM)

This motherboard provides four 288-pin DDR4 (Double Data Rate 4) DIMM slots, and supports Dual Channel Memory Technology.



1. For dual channel configuration, you always need to install identical (the same brand, speed, size and chip-type) DDR4 DIMM pairs.
2. It is unable to activate Dual Channel Memory Technology with only one or three memory module installed.
3. It is not allowed to install a DDR, DDR2 or DDR3 memory module into a DDR4 slot; otherwise, this motherboard and DIMM may be damaged.

Dual Channel Memory Configuration

Priority	DDR4_A1	DDR4_A2	DDR4_B1	DDR4_B2
1		Populated		Populated
2	Populated	Populated	Populated	Populated



The DIMM only fits in one correct orientation. It will cause permanent damage to the motherboard and the DIMM if you force the DIMM into the slot at incorrect orientation.

1

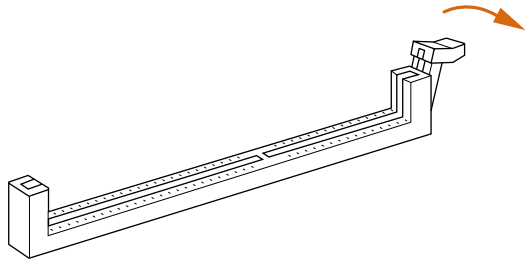

2

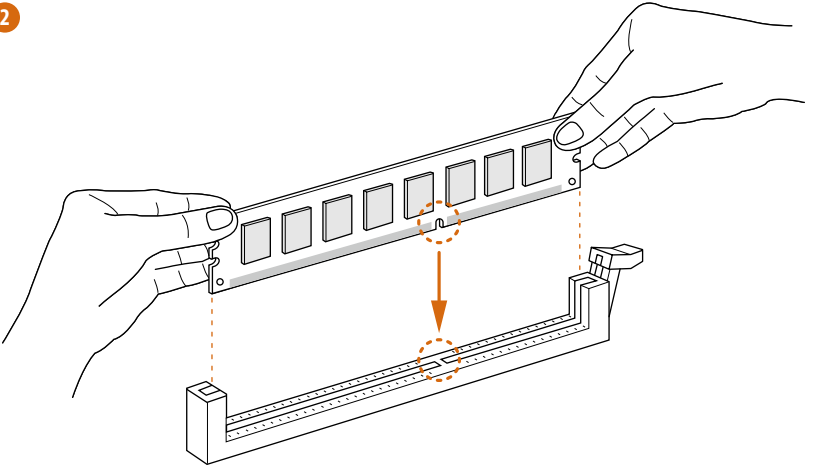

3

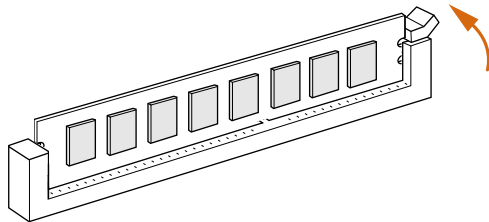

2.4 Expansion Slots (PCI Express Slots)

There are 6 PCI Express slots on the motherboard.



Before installing an expansion card, please make sure that the power supply is switched off or the power cord is unplugged. Please read the documentation of the expansion card and make necessary hardware settings for the card before you start the installation.

PCIe slots:

PCIE1 (PCIe 3.0 x1 slot) is used for PCI Express x1 lane width cards.

PCIE2 (PCIe 3.0 x16 slot) is used for PCI Express x16 lane width graphics cards.

PCIE3 (PCIe 3.0 x1 slot) is used for PCI Express x1 lane width cards.

PCIE4 (PCIe 3.0 x16 slot) is used for PCI Express x8 lane width graphics cards.

PCIE5 (PCIe 3.0 x1 slot) is used for PCI Express x1 lane width cards.

PCIE6 (PCIe 3.0 x16 slot) is used for PCI Express x4 lane width graphics cards.

PCIe Slot Configurations

	PCIE2	PCIE4	PCIE6
Single Graphics Card	x16	N/A	N/A
Two Graphics Cards in CrossFireX™ or SLI™ Mode	x8	x8	N/A
Three Graphics Cards in 3-Way CrossFireX™ Mode	x8	x8	x4



For a better thermal environment, please connect a chassis fan to the motherboard's chassis fan connector (CHA_FAN1, CHA_FAN2 or CHA_FAN3) when using multiple graphics cards.

2.5 Jumpers Setup

The illustration shows how jumpers are setup. When the jumper cap is placed on the pins, the jumper is “Short”. If no jumper cap is placed on the pins, the jumper is “Open”.

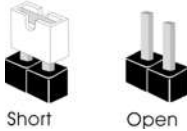

Clear CMOS Jumper
(CLRCMOS1)
(see p.8, No. 28)

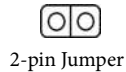

Short: Clear CMOS
Open: Default

CLRCMOS1 allows you to clear the data in CMOS. The data in CMOS includes system setup information such as system password, date, time, and system setup parameters. To clear and reset the system parameters to default setup, please turn off the computer and unplug the power cord, then use a jumper cap to short the pins on CLRCMOS1 for 3 seconds. Please remember to remove the jumper cap after clearing the CMOS. If you need to clear the CMOS when you just finish updating the BIOS, you must boot up the system first, and then shut it down before you do the clear-CMOS action.

2.6 Onboard Headers and Connectors



Onboard headers and connectors are NOT jumpers. Do NOT place jumper caps over these headers and connectors. Placing jumper caps over the headers and connectors will cause permanent damage to the motherboard.

System Panel Header
(9-pin PANEL1)
(see p.8, No. 16)

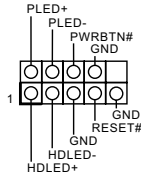

Connect the power button, reset button and system status indicator on the chassis to this header according to the pin assignments below. Note the positive and negative pins before connecting the cables.



PWRBTN (Power Button):

Connect to the power button on the chassis front panel. You may configure the way to turn off your system using the power button.

RESET (Reset Button):

Connect to the reset button on the chassis front panel. Press the reset button to restart the computer if the computer freezes and fails to perform a normal restart.

PLED (System Power LED):

Connect to the power status indicator on the chassis front panel. The LED is on when the system is operating. The LED keeps blinking when the system is in S1/S3 sleep state. The LED is off when the system is in S4 sleep state or powered off (S5).

HDLED (Hard Drive Activity LED):

Connect to the hard drive activity LED on the chassis front panel. The LED is on when the hard drive is reading or writing data.

The front panel design may differ by chassis. A front panel module mainly consists of power button, reset button, power LED, hard drive activity LED, speaker and etc. When connecting your chassis front panel module to this header, make sure the wire assignments and the pin assignments are matched correctly.

Power LED and Speaker Header
 (7-pin SPK_PLED1)
 (see p.8, No. 17)

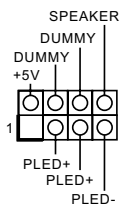

Please connect the chassis power LED and the chassis speaker to this header.

Serial ATA3 Connectors
 (SATA3_4_5:
 see p.8, No. 12)
 (SATA3_2_3:
 see p.8, No. 13)
 (SATA3_0_1:
 see p.8, No. 14)
 (SATA3_A1_A2:
 see p.8, No. 15)

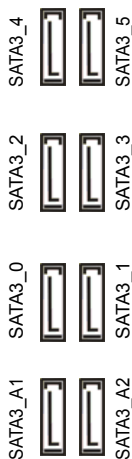

These eight SATA3 connectors support SATA data cables for internal storage devices with up to 6.0 Gb/s data transfer rate.
 * M2_1, SATA3_0 and SATA3_1 share lanes. If either one of them is in use, the others will be disabled.
 * M2_2, SATA3_4 and SATA3_5 share lanes. If either one of them is in use, the others will be disabled.
 *To minimize the boot time, use Intel® Z370 SATA ports (SATA3_0) for your bootable devices.

USB 2.0 Headers
 (9-pin USB_1_2)
 (see p.8, No. 21)
 (9-pin USB_3_4)
 (see p.8, No. 22)
 (9-pin USB_5_6)
 (see p.8, No. 20)

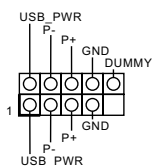

There are three headers on this motherboard. Each USB 2.0 header can support two ports.

USB 3.1 Gen1 Headers

(19-pin USB3_5_6)

(see p.8, No. 9)

(19-pin USB3_7_8)

(see p.8, No. 10)

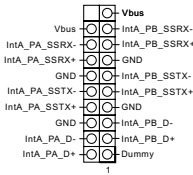

There are two headers on this motherboard. Each USB 3.1 Gen1 header can support two ports.

Front Panel Type C USB

3.1 Gen1 Header

(26-pin USB3_TC_1)

(see p.8, No. 11)



There is one Front Panel Type C USB 3.1 Gen1 Header on this motherboard. This header is used for connecting a USB 3.1 Gen1 module for additional USB 3.1 Gen1 ports.

Front Panel Audio Header

(9-pin HD_AUDIO1)

(see p.8, No. 29)

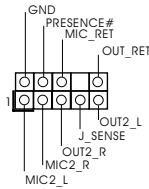

This header is for connecting audio devices to the front audio panel.



1. High Definition Audio supports Jack Sensing, but the panel wire on the chassis must support HDA to function correctly. Please follow the instructions in our manual and chassis manual to install your system.
2. If you use an AC'97 audio panel, please install it to the front panel audio header by the steps below:
 - A. Connect Mic_IN (MIC) to MIC2_L.
 - B. Connect Audio_R (RIN) to OUT2_R and Audio_L (LIN) to OUT2_L.
 - C. Connect Ground (GND) to Ground (GND).
 - D. MIC_RET and OUT_RET are for the HD audio panel only. You don't need to connect them for the AC'97 audio panel.
 - E. To activate the front mic, go to the "FrontMic" Tab in the Realtek Control panel and adjust "Recording Volume".

Chassis Fan Connectors

(4-pin CHA_FAN1)

(see p.8, No. 30)

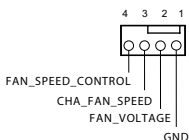

Please connect fan cables to the fan connectors and match the black wire to the ground pin.

(4-pin CHA_FAN2)

(see p.8, No. 24)

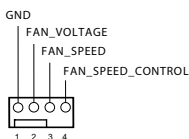

Chassis Optional/Water Pump Fan Connector

(4-pin CHA_FAN3/W_PUMP)

(see p.8, No. 18)

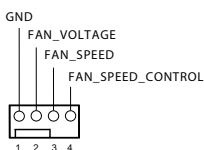

This motherboard provides a 4-Pin water cooling chassis fan connectors. If you plan to connect a 3-Pin chassis water cooler fan, please connect it to Pin 1-3.

CPU Fan Connector

(4-pin CPU_FAN1)

(see p.8, No. 2)

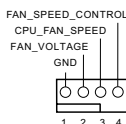

This motherboard provides a 4-Pin CPU fan (Quiet Fan) connector. If you plan to connect a 3-Pin CPU fan, please connect it to Pin 1-3.

CPU Optional/Water Pump Fan Connector

(4-pin CPU_OPT/W_PUMP)

(see p.8, No. 3)

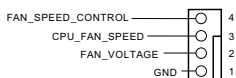

This motherboard provides a 4-Pin water cooling CPU fan connector. If you plan to connect a 3-Pin CPU water cooler fan, please connect it to Pin 1-3.

ATX Power Connector

(24-pin ATXPWR1)

(see p.8, No. 8)

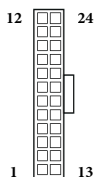

This motherboard provides a 24-pin ATX power connector. To use a 20-pin ATX power supply, please plug it along Pin 1 and Pin 13.

ATX 12V Power Connector
(8-pin ATX12V1)
(see p.8, No. 1)

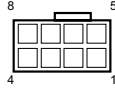

This motherboard provides an 8-pin ATX 12V power connector. To use a 4-pin ATX power supply, please plug it along Pin 1 and Pin 5.

Thunderbolt AIC Connectors
(5-pin TB1)
(see p.8, No. 25)



Please connect a Thunderbolt™ add-in card (AIC) to the Thunderbolt AIC connector via the GPIO cable.

*Please install the Thunderbolt™ AIC card to PCIe6 (default slot).

Serial Port Header
(9-pin COM1)
(see p.8, No. 19)

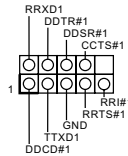

This COM1 header supports a serial port module.

TPM Header
(17-pin TPM1)
(see p.8, No. 23)

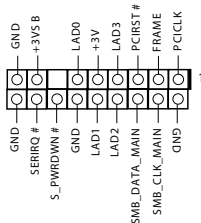

This connector supports Trusted Platform Module (TPM) system, which can securely store keys, digital certificates, passwords, and data. A TPM system also helps enhance network security, protects digital identities, and ensures platform integrity.

RGB LED Header
(4-pin RGB_LED)
(see p.8, No. 26)



RGB header is used to connect RGB LED extension cable which allows users to choose from various LED lighting effects.

Caution: Never install the RGB LED cable in the wrong orientation; otherwise, the cable may be damaged.

*Please refer to page 53 for further instructions on this header.

2.7 Smart Switches

The motherboard has three smart switches: Power Button, Reset Button and XMP Switch, allowing users to quickly turn on/off the system, reset the system or load XMP profiles.

Power Button
(PWRBTN)
(see p.8, No. 6)



Power Button allows users to quickly turn on/off the system.

Reset Button
(RSTBTN)
(see p.8, No. 7)



Reset Button allows users to quickly reset the system.

XMP Switch
(XMP_ON1)
(see p.8, No. 27)



The XMP switch allows users to easily load XMP profiles to automatically configure the overclocked DRAM voltages for stable operation.

2.8 Dr. Debug

Dr. Debug is used to provide code information, which makes troubleshooting even easier. Please see the diagrams below for reading the Dr. Debug codes.

Code	Description
00	Please check if the CPU is installed correctly and then clear CMOS.
0d	Problem related to memory, VGA card or other devices. Please clear CMOS, re-install the memory and VGA card, and remove other USB, PCI devices.
01 - 54 (except 0d), 5A- 60	Problem related to memory. Please re-install the CPU and memory then clear CMOS. If the problem still exists, please install only one memory module or try using other memory modules.
55	The Memory could not be detected. Please re-install the memory and CPU. If the problem still exists, please install only one memory module or try using other memory modules.
61 - 91	Chipset initialization error. Please press reset or clear CMOS.
92 - 99	Problem related to PCI-E devices. Please re-install PCI-E devices or try installing them in other slots. If the problem still exists, please remove all PCI-E devices or try using another VGA card.
A0 - A7	Problem related to IDE or SATA devices. Please re-install IDE and SATA devices. If the problem still exists, please clear CMOS and try removing all SATA devices.
b0	Problem related to memory. Please re-install the CPU and memory. If the problem still exists, please install only one memory module or try using other memory modules.

- b4 Problem related to USB devices. Please try removing all USB devices.
- b7 Problem related to memory. Please re-install the CPU and memory then clear CMOS. If the problem still exists, please install only one memory module or try using other memory modules.
- d6 The VGA could not be recognized. Please clear CMOS and try re-installing the VGA card. If the problem still exists, please try installing the VGA card in other slots or use other VGA cards.
- d7 The Keyboard and mouse could not be recognized. Please try re-installing the keyboard and mouse.
- d8 Invalid Password.
- FF Please check if the CPU is installed correctly and then clear CMOS.

2.9 SLI™ and Quad SLI™ Operation Guide

This motherboard supports NVIDIA® SLI™ and Quad SLI™ (Scalable Link Interface) technology that allows you to install up to two identical PCI Express x16 graphics cards.



Requirements

1. You should only use identical SLI™-ready graphics cards that are NVIDIA® certified.
2. Make sure that your graphics card driver supports NVIDIA® SLI™ technology. Download the drivers from the NVIDIA® website: www.nvidia.com
3. Make sure that your power supply unit (PSU) can provide at least the minimum power your system requires. It is recommended to use a NVIDIA® certified PSU. Please refer to the NVIDIA® website for details.

2.9.1 Installing Two SLI™-Ready Graphics Cards

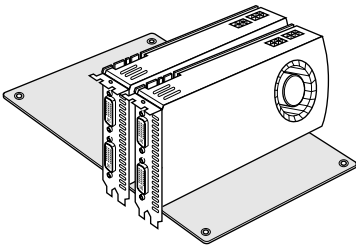

Step 1

Insert one graphics card into PCIE2 slot and the other graphics card to PCIE4 slot. Make sure that the cards are properly seated on the slots.

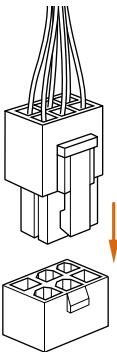

Step 2

If required, connect the auxiliary power source to the PCI Express graphics cards.

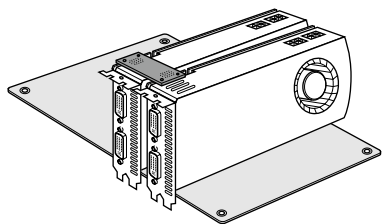

Step 3

Align and insert the ASRock SLI_HB_Bridge_2S Card to the goldfingers on each graphics card. Make sure the ASRock SLI_HB_Bridge_2S Card is firmly in place.

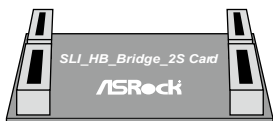

ASRock SLI_HB_Bridge_2S Card

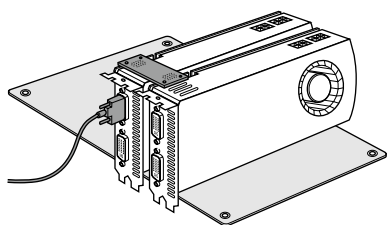

Step 4

Connect a VGA cable or a DVI cable to the monitor connector or the DVI connector of the graphics card that is inserted to PCIE2 slot.

2.9.2 Driver Installation and Setup

Install the graphics card drivers to your system. After that, you can enable the Multi-Graphics Processing Unit (GPU) in the NVIDIA® nView system tray utility. Please follow the below procedures to enable the multi-GPU.

For SLI™ and Quad SLI™ mode



Step 1

Double-click the **NVIDIA Control Panel** icon in the Windows® system tray.



Step 2

In the left pane, click **Set SLI and PhysX configuration**. Then select **Maximize 3D performance** and click **Apply**.

Step 3

Reboot your system.

Step 4

You can freely enjoy the benefits of SLI™ or Quad SLI™.

2.10 CrossFireX™, 3-Way CrossFireX™ and Quad CrossFireX™ Operation Guide

This motherboard supports CrossFireX™, 3-way CrossFireX™ and Quad CrossFireX™ that allows you to install up to three identical PCI Express x16 graphics cards.



1. You should only use identical CrossFireX™-ready graphics cards that are AMD certified.
2. Make sure that your graphics card driver supports AMD CrossFireX™ technology. Download the drivers from the AMD's website: www.amd.com
3. Make sure that your power supply unit (PSU) can provide at least the minimum power your system requires. It is recommended to use a AMD certified PSU. Please refer to the AMD's website for details.
4. If you pair a 12-pipe CrossFireX™ Edition card with a 16-pipe card, both cards will operate as 12-pipe cards while in CrossFireX™ mode.
5. Different CrossFireX™ cards may require different methods to enable CrossFireX™. Please refer to AMD graphics card manuals for detailed installation guide.

2.10.1 Installing Two CrossFireX™-Ready Graphics Cards

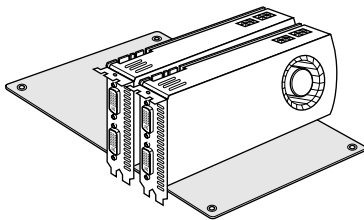

Step 1

Insert one graphics card into PCIe2 slot and the other graphics card to PCIe4 slot. Make sure that the cards are properly seated on the slots.



CrossFire Bridge

Step 2

Connect two graphics cards by installing a CrossFire Bridge on the CrossFire Bridge Interconnects on the top of the graphics cards. (The CrossFire Bridge is provided with the graphics card you purchase, not bundled with this motherboard. Please refer to your graphics card vendor for details.)

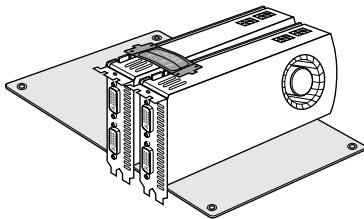

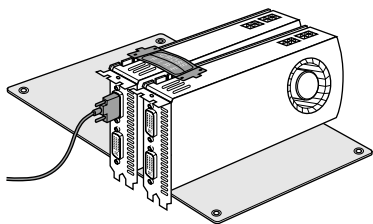

Step 3

Connect a VGA cable or a DVI cable to the monitor connector or the DVI connector of the graphics card that is inserted to PCIE2 slot.

2.10.2 Installing Three CrossFireX™-Ready Graphics Cards

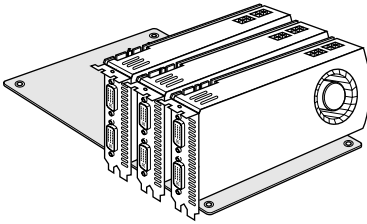

Step 1

Insert one graphics card into PCI E2 slot, another graphics card to PCI E4 slot, and the other graphics card to PCI E6 slot. Make sure that the cards are properly seated on the slots.



CrossFire Bridge

Step 2

Use one CrossFire Bridge to connect the graphics cards on PCI E2 and PCI E4 slots, and use the other CrossFire Bridge to connect the graphics cards on PCI E4 and PCI E6 slots. (The CrossFire Bridge is provided with the graphics card you purchase, not bundled with this motherboard. Please refer to your graphics card vendor for details.)

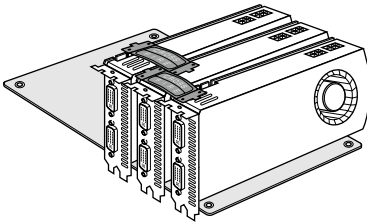

Step 3

Connect a VGA cable or a DVI cable to the monitor connector or the DVI connector of the graphics card that is inserted to PCI E2 slot.

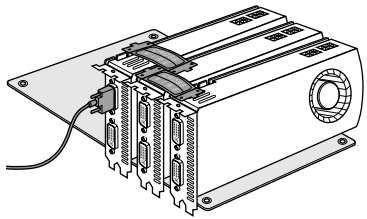

2.10.3 Driver Installation and Setup

Step 1

Power on your computer and boot into OS.

Step 2

Remove the AMD drivers if you have any VGA drivers installed in your system.



The Catalyst Uninstaller is an optional download. We recommend using this utility to uninstall any previously installed Catalyst drivers prior to installation. Please check AMD's website for AMD driver updates.

Step 3

Install the required drivers and CATALYST Control Center then restart your computer. Please check AMD's website for details.



AMD Catalyst Control Center

Step 4

Double-click the **AMD Catalyst Control Center** icon in the Windows[®] system tray.



Step 5

In the left pane, click **Performance** and then **AMD CrossFireX™**. Then select **Enable AMD CrossFireX** and click **Apply**. Select the GPU number according to your graphics card and click **Apply**.

2.11 M.2 WiFi/BT Module Installation Guide (M2_3)

The M.2 Socket (Key E) supports type 2230 WiFi/BT module.

Installing the WiFi/BT module

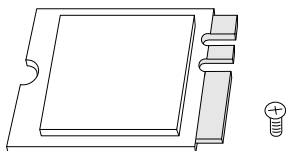

Step 1

Prepare a type 2230 WiFi/BT module and the screw.

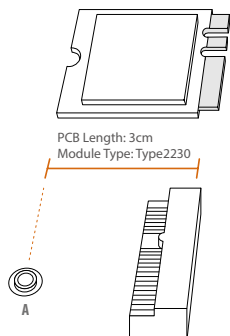

Step 2

Find the nut location to be used.

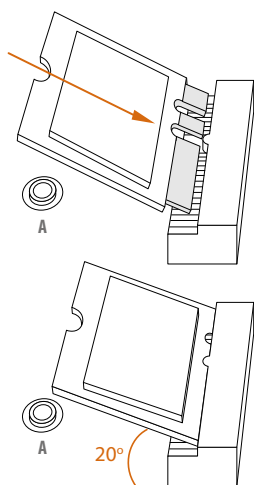

Step 3

Align and gently insert the WiFi/BT module into the M.2 slot. Please be aware that the module only fits in one orientation.

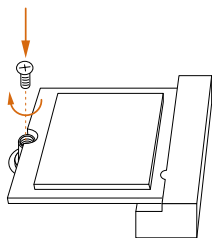

Step 4

Tighten the screw with a screwdriver to secure the module into place. Please do not overtighten the screw as this might damage the module.

2.12 M.2_SSD (NGFF) Module Installation Guide (M2_1 and M2_2)

The M.2, also known as the Next Generation Form Factor (NGFF), is a small size and versatile card edge connector that aims to replace mPCIe and mSATA. The Ultra M.2 Sockets (M2_1 and M2_2) support SATA3 6.0 Gb/s module and M.2 PCI Express module up to Gen3 x4 (32 Gb/s).

* M2_1, SATA3_0 and SATA3_1 share lanes. If either one of them is in use, the others will be disabled.

* M2_2, SATA3_4 and SATA3_5 share lanes. If either one of them is in use, the others will be disabled.

Installing the M.2_SSD (NGFF) Module

The following is an example of installing M.2_SSD (NGFF) module into the M2_2.

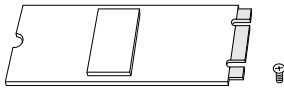

Step 1

Prepare a M.2_SSD (NGFF) module and the screw.

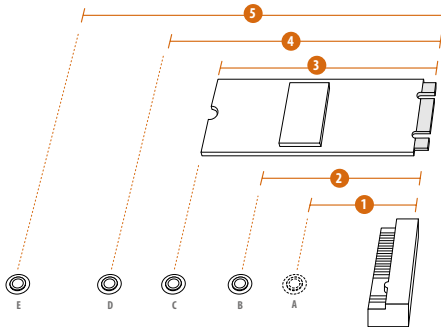

Step 2

Depending on the PCB type and length of your M.2_SSD (NGFF) module, find the corresponding nut location to be used.

No.	1	2	3	4	5
Nut Location	A	B	C	D	E
PCB Length	3cm	4.2cm	6cm	8cm	11cm
Module Type	Type2230	Type 2242	Type2260	Type 2280	Type 22110

Step 3



Move the standoff based on the module type and length. The standoff is placed at the nut location D by default. Skip Step 3 and 4 and go straight to Step 5 if you are going to use the default nut. Otherwise, release the standoff by hand.

Step 4



Peel off the yellow protective film on the nut to be used. Hand tighten the standoff into the desired nut location on the motherboard.

Step 5

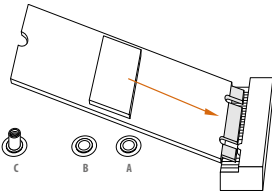

Align and gently insert the M.2 (NGFF) SSD module into the M.2 slot. Please be aware that the M.2 (NGFF) SSD module only fits in one orientation.

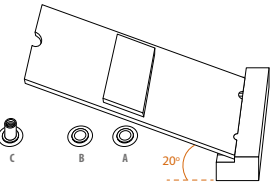

Step 6

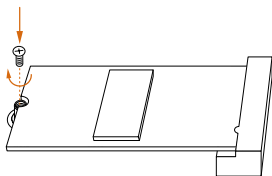

Tighten the screw with a screwdriver to secure the module into place. Please do not overtighten the screw as this might damage the module.

M.2_SSD (NGFF) Module Support List

Vendor	Interface	P/N
ADATA	SATA3	AXNS330E-32GM-B
ADATA	SATA3	AXNS381E-128GM-B
ADATA	SATA3	AXNS381E-256GM-B
ADATA	SATA3	ASU800NS38-256GT-C
ADATA	SATA3	ASU800NS38-512GT-C
ADATA	PCIe3 x4	ASX7000NP-128GT-C
ADATA	PCIe3 x4	ASX8000NP-256GM-C
ADATA	PCIe3 x4	ASX7000NP-256GT-C
ADATA	PCIe3 x4	ASX8000NP-512GM-C
ADATA	PCIe3 x4	ASX7000NP-512GT-C
Apacer	PCIe3 x4	AP240GZ280
Corsair	PCIe3 x4	CSSD-F240GBMP500
Crucial	SATA3	CT120M500SSD4
Crucial	SATA3	CT240M500SSD4
Intel	SATA3	Intel SSDSCKGW080A401/80G
Intel	PCIe3 x4	SSDPEKKF256G7
Intel	PCIe3 x4	SSDPEKKF512G7
Kingston	SATA3	SM2280S3
Kingston	PCIe3 x4	SKC1000/480G
Kingston	PCIe2 x4	SH2280S3/480G
OCZ	PCIe3 x4	RVD400 -M2280-512G (NVME)
PATRIOT	PCIe3 x4	PH240GPM280SSDR NVME
Plextor	PCIe3 x4	PX-128M8PeG
Plextor	PCIe3 x4	PX-1TM8PeG
Plextor	PCIe3 x4	PX-256M8PeG
Plextor	PCIe3 x4	PX-512M8PeG
Plextor	PCIe	PX-G256M6e
Plextor	PCIe	PX-G512M6e
Samsung	PCIe3 x4	SM961 MZVPW128HEGM (NVM)
Samsung	PCIe3 x4	PM961 MZVLW128HEGR (NVME)
Samsung	PCIe3 x4	960 EVO (MZ-V6E250) (NVME)
Samsung	PCIe3 x4	960 EVO (MZ-V6E250BW) (NVME)
Samsung	PCIe3 x4	SM951 (NVME)
Samsung	PCIe3 x4	SM951 (MZHPV256HDGL)
Samsung	PCIe3 x4	SM951 (MZHPV512HDGL)
Samsung	PCIe3 x4	SM951 (NVME)
Samsung	PCIe x4	XP941-512G (MZHPU512HCGL)
SanDisk	PCIe	SD6PP4M-128G
SanDisk	PCIe	SD6PP4M-256G
Team	SATA3	TM4PS4128GMC105
Team	SATA3	TM4PS4256GMC105
Team	SATA3	TM8PS4128GMC105
Team	SATA3	TM8PS4256GMC105

TEAM	PCIe3 x4	TM8FP2240G0C101
TEAM	PCIe3 x4	TM8FP2480GC110
Transcend	SATA3	TS256GMTS400
Transcend	SATA3	TS512GMTS600
Transcend	SATA3	TS512GMTS800
V-Color	SATA3	VLM100-120G-2280B-RD
V-Color	SATA3	VLM100-240G-2280RGB
V-Color	SATA3	VSM100-240G-2280
V-Color	SATA3	VLM100-240G-2280B-RD
WD	SATA3	WDS100T1B0B-00AS40
WD	SATA3	WDS240G1G0B-00RC30
WD	PCIe3 x4	WDS256G1X0C-00ENX0 (NVME)
WD	PCIe3 x4	WDS512G1X0C-00ENX0 (NVME)

For the latest updates of M.2_SSD (NFGG) module support list, please visit our website for details: <http://www.asrock.com>

Chapter 3 Software and Utilities Operation

3.1 Installing Drivers

The Support CD that comes with the motherboard contains necessary drivers and useful utilities that enhance the motherboard's features.

Running The Support CD

To begin using the support CD, insert the CD into your CD-ROM drive. The CD automatically displays the Main Menu if "AUTORUN" is enabled in your computer. If the Main Menu does not appear automatically, locate and double click on the file "ASRSETUP.EXE" in the Support CD to display the menu.

Drivers Menu

The drivers compatible to your system will be auto-detected and listed on the support CD driver page. Please click **Install All** or follow the order from top to bottom to install those required drivers. Therefore, the drivers you install can work properly.

Utilities Menu

The Utilities Menu shows the application software that the motherboard supports. Click on a specific item then follow the installation wizard to install it.

3.2 F-Stream

F-Stream is ASRock's multi purpose software suite with a new interface, more new features and improved utilities.

3.2.1 Installing F-Stream

F-Stream can be downloaded from ASRock Live Update & APP Shop. After the installation, you will find the icon "F-Stream" on your desktop. Double-click the "F-Stream"  icon, F-Stream main menu will pop up.

3.2.2 Using F-Stream

There are five sections in F-Stream main menu: Operation Mode, OC Tweaker, System Info, FAN-Tastic Tuning and Settings.

Operation Mode

Choose an operation mode for your computer.

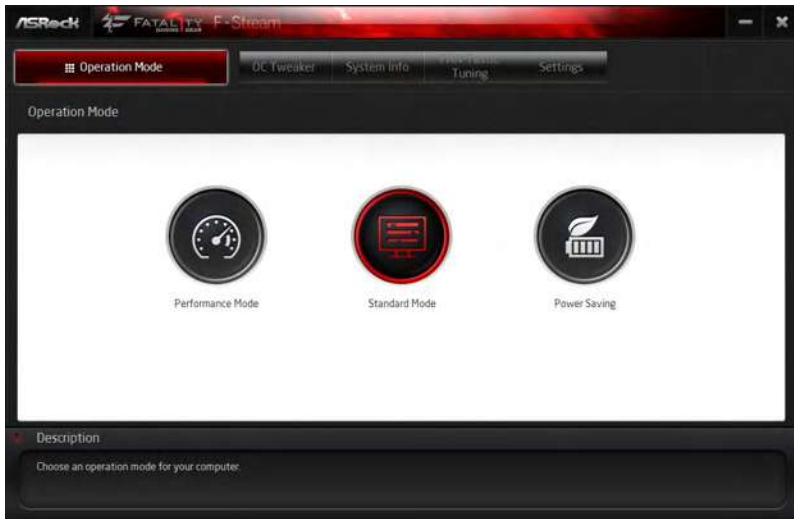

OC Tweaker

Configurations for overclocking the system.



System Info

View information about the system.

*The System Browser tab may not appear for certain models.

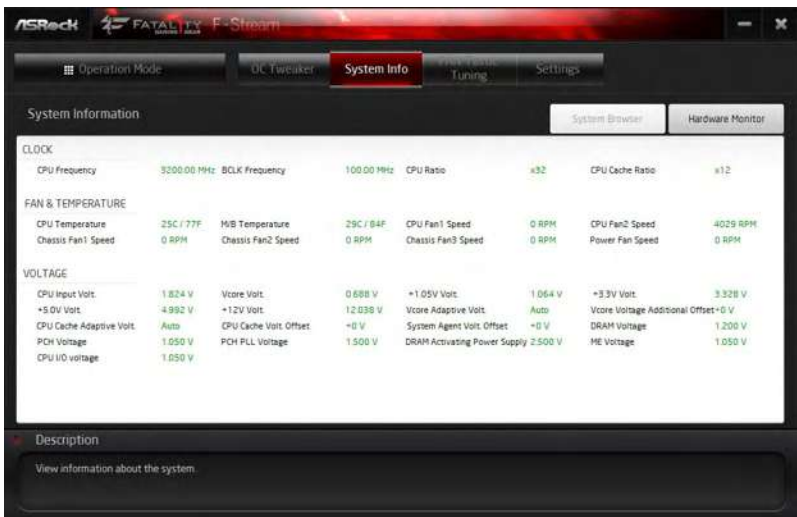

FAN-Tastic Tuning

Configure up to five different fan speeds using the graph. The fans will automatically shift to the next speed level when the assigned temperature is met.

The screenshot shows the 'FAN-Tastic Tuning' window. At the top, there are tabs for 'Operation Mode', 'OC Tweaker', 'System Info', 'FAN-Tastic Tuning', and 'Settings'. The 'FAN-Tastic Tuning' tab is selected. Below the tabs, there is a 'Back' button and the text 'FAN-Tastic Tuning'. The main area contains a graph on the left and a table on the right. The graph plots 'Fan Speed (%)' on the y-axis (0 to 100) against 'Temperature (C)' on the x-axis (0 to 100). A red line shows a step-like increase in fan speed as temperature rises. The table on the right lists 'Fan Power' and 'Fan Speed' for various percentages from 100% down to 10%. The 'Fan Speed' column contains 'N/A RPM' for all entries. There is a 'Start FAN Test' button and an 'Auto apply when program starts' checkbox. An illustration of a computer monitor and a fan is also present.

Fan Power	Fan Speed
100%	N/A RPM
90%	N/A RPM
80%	N/A RPM
70%	N/A RPM
60%	N/A RPM
50%	N/A RPM
40%	N/A RPM
30%	N/A RPM
20%	N/A RPM
10%	N/A RPM

Auto apply when program starts

Apply **Cancel**

Description

Configure different fan speeds for respective temperatures using the graph. The fans will automatically shift to the next speed level when the assigned temperature is met.

Settings

Configure ASRock F-Stream. Click to select "Auto run at Windows Startup" if you want F-Stream to be launched when you start up the Windows operating system.

The screenshot shows the 'Settings' window. At the top, there are tabs for 'Operation Mode', 'OC Tweaker', 'System Info', 'FAN-Tastic Tuning', and 'Settings'. The 'Settings' tab is selected. Below the tabs, there is a 'Back' button and the text 'Settings'. The main area contains a single checkbox labeled 'Auto run at Windows Startup'. The checkbox is currently unchecked. In the bottom right corner, it says 'Version 1.3.0.0'. A 'Description' section at the bottom states 'Configure ASRock F-Stream'.

Auto run at Windows Startup

Version 1.3.0.0

Description

Configure ASRock F-Stream

3.3 ASRock Live Update & APP Shop

The ASRock Live Update & APP Shop is an online store for purchasing and downloading software applications for your ASRock computer. You can quickly and easily install various apps and support utilities. With ASRock APP Shop, you can optimize your system and keep your motherboard up to date simply with a few clicks.

Double-click  on your desktop to access ASRock Live Update & APP Shop utility.

**You need to be connected to the Internet to download apps from the ASRock Live Update & APP Shop.*

3.3.1 UI Overview

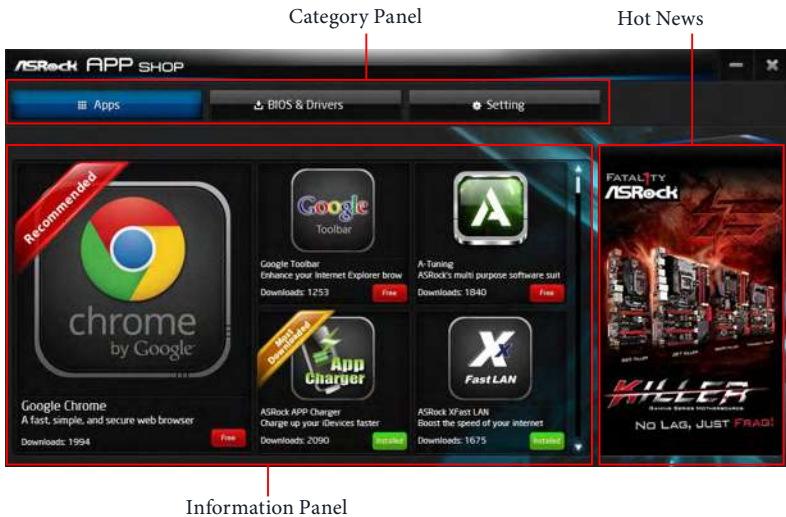

Category Panel: The category panel contains several category tabs or buttons that when selected the information panel below displays the relative information.

Information Panel: The information panel in the center displays data about the currently selected category and allows users to perform job-related tasks.

Hot News: The hot news section displays the various latest news. Click on the image to visit the website of the selected news and know more.

3.3.2 Apps

When the "Apps" tab is selected, you will see all the available apps on screen for you to download.

Installing an App

Step 1

Find the app you want to install.



The most recommended app appears on the left side of the screen. The other various apps are shown on the right. Please scroll up and down to see more apps listed.

You can check the price of the app and whether you have already installed it or not.

Free - The red icon displays the price or "Free" if the app is free of charge.

Installed - The green "Installed" icon means the app is installed on your computer.

Step 2

Click on the app icon to see more details about the selected app.

Step 3

If you want to install the app, click on the red icon  to start downloading.



Step 4

When installation completes, you can find the green "Installed" icon appears on the upper right corner.



To uninstall it, simply click on the trash can icon .

*The trash icon may not appear for certain apps.

Upgrading an App

You can only upgrade the apps you have already installed. When there is an available new version for your app, you will find the mark of "New Version"  appears below the installed app icon.



Step 1

Click on the app icon to see more details.

Step 2

Click on the yellow icon  to start upgrading.

3.3.3 BIOS & Drivers

Installing BIOS or Drivers

When the "BIOS & Drivers" tab is selected, you will see a list of recommended or critical updates for the BIOS or drivers. Please update them all soon.

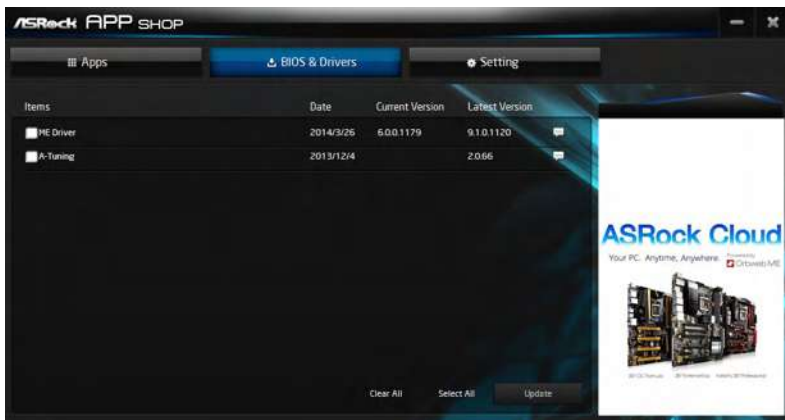

Step 1

Please check the item information before update. Click on  to see more details.

Step 2

Click to select one or more items you want to update.

Step 3

Click Update to start the update process.

3.3.4 Setting

In the "Setting" page, you can change the language, select the server location, and determine if you want to automatically run the ASRock Live Update & APP Shop on Windows startup.

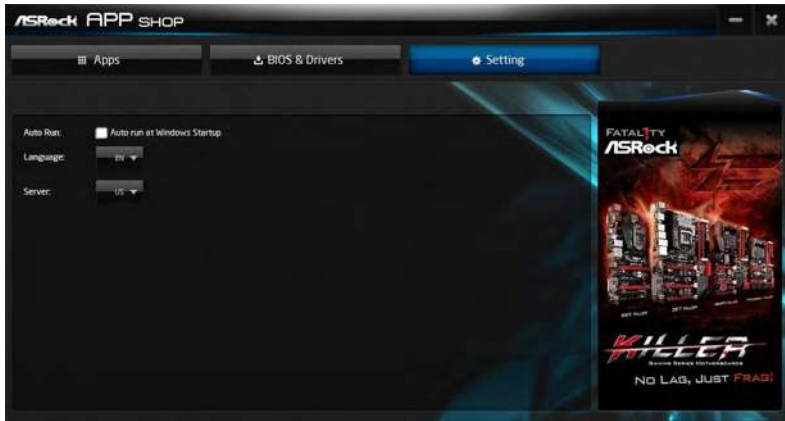

3.4 Creative SoundBlaster Cinema3

The SoundBlaster™ Cinema3, powered by the SBX Pro Studio technologies, is designed to bring the same great audio experience found in live performances, films, and recording studios to the PC. With this utility, you can easily enhance your audio environment in five modes, including Headphones, Speakers, Music, Movie, Game, Voice and Custom.

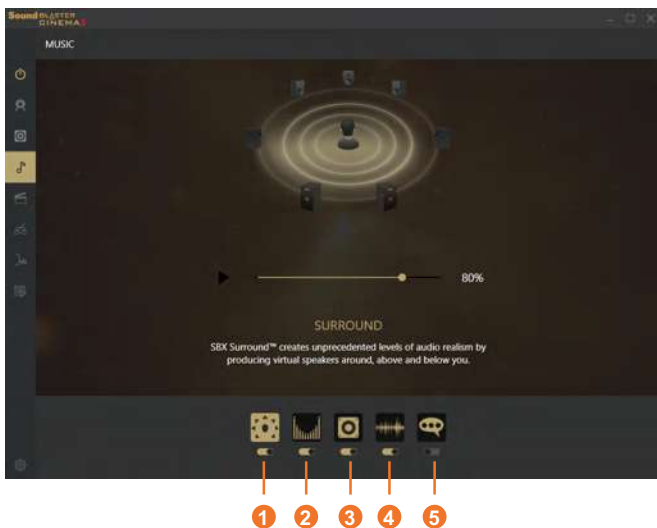

There are five functions in SoundBlaster™ Cinema3:

No.	Function	Description
1	Surround	Creating unprecedented levels of audio realism by producing virtual speakers around, above and below you.
2	Crystalizer	Making music sound as good as the artist originally intended by ensuring that every audio detail is heard.
3	Bass	Enhancing bass sound experience by expanding the low frequency tones.
4	Smart Volume	Minimizing abrupt volume changes by automatically adjusting the loudness of your audio playback.
5	Dialog Plus	Enhancing voices in music and movies for drastically clearer vocal range.

3.5 ASRock RGB LED

ASRock RGB LED is a lighting control utility specifically designed for unique individuals with sophisticated tastes to build their own stylish colorful lighting system. Simply by connecting the LED strip, you can customize various lighting schemes and patterns, including Static, Breathing, Strobe, Cycling, Music, Wave and more.

Connecting the LED Strip

Connect your RGB LED strips to the **RGB LED Header (RGB_LED)** on the motherboard.

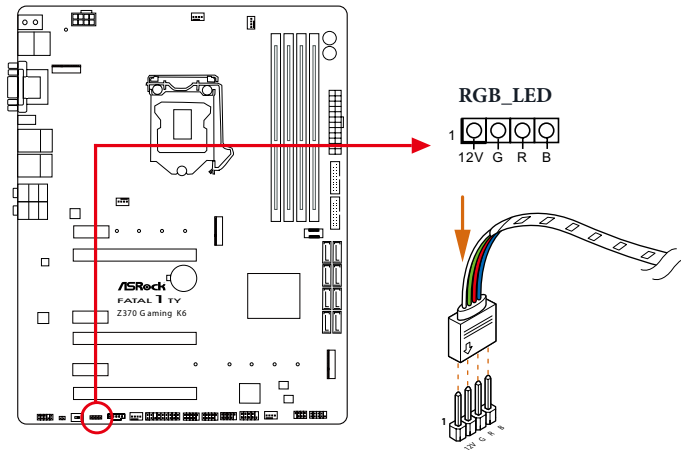

1. Never install the RGB LED cable in the wrong orientation; otherwise, the cable may be damaged.
2. Before installing or removing your RGB LED cable, please power off your system and unplug the power cord from the power supply. Failure to do so may cause damages to motherboard components.



1. Please note that the RGB LED strips do not come with the package.
2. The RGB LED header supports standard 5050 RGB LED strip (12V/G/R/B), with a maximum power rating of 3A (12V) and length within 2 meters.

ASRock RGB LED Utility

Now you can adjust the RGB LED color through the ASRock RGB LED utility. Download this utility from the ASRock Live Update & APP Shop and start coloring your PC style your way!

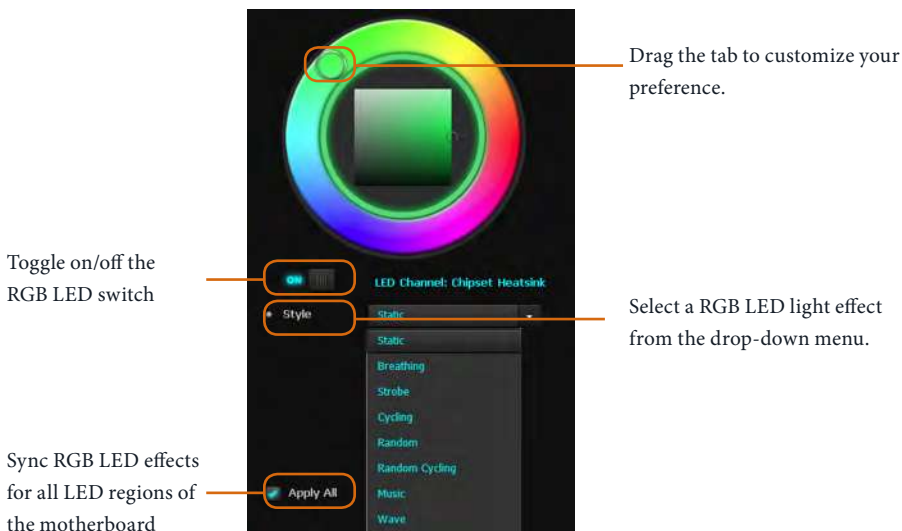

Chapter 4 UEFI SETUP UTILITY

4.1 Introduction

This section explains how to use the UEFI SETUP UTILITY to configure your system. You may run the UEFI SETUP UTILITY by pressing <F2> or right after you power on the computer, otherwise, the Power-On-Self-Test (POST) will continue with its test routines. If you wish to enter the UEFI SETUP UTILITY after POST, restart the system by pressing <Ctl> + <Alt> + <Delete>, or by pressing the reset button on the system chassis. You may also restart by turning the system off and then back on.



Because the UEFI software is constantly being updated, the following UEFI setup screens and descriptions are for reference purpose only, and they may not exactly match what you see on your screen.

4.2 EZ Mode

The EZ Mode screen appears when you enter the BIOS setup program by default. EZ mode is a dashboard which contains multiple readings of the system's current status. You can check the most crucial information of your system, such as CPU speed, DRAM frequency, SATA information, fan speed, etc.

Press <F6> or click the "Advanced Mode" button at the upper right corner of the screen to switch to "Advanced Mode" for more options.



No.	Function
1	Help
2	Load UEFI Defaults
3	Save Changes and Exit
4	Discard Changes
5	Change Language
6	Switch to Advanced Mode

4.3 Advanced Mode

The Advanced Mode provides more options to configure the BIOS settings. Refer to the following sections for the detailed configurations.

To access the EZ Mode, press <F6> or click the "EZ Mode" button at the upper right corner of the screen.

4.3.1 UEFI Menu Bar

The top of the screen has a menu bar with the following selections:

Main	For setting system time/date information
OC Tweaker	For overclocking configurations
Advanced	For advanced system configurations
Tool	Useful tools
H/W Monitor	Displays current hardware status
Security	For security settings
Boot	For configuring boot settings and boot priority
Exit	Exit the current screen or the UEFI Setup Utility

4.3.2 Navigation Keys

Use <←> key or <→> key to choose among the selections on the menu bar, and use <↑> key or <↓> key to move the cursor up or down to select items, then press <Enter> to get into the sub screen. You can also use the mouse to click your required item.

Please check the following table for the descriptions of each navigation key.

Navigation Key(s)	Description
+ / -	To change option for the selected items
<Tab>	Switch to next function
<PGUP>	Go to the previous page
<PGDN>	Go to the next page
<HOME>	Go to the top of the screen
<END>	Go to the bottom of the screen
<F1>	To display the General Help Screen
<F5>	Add / Remove Favorite
<F7>	Discard changes and exit the SETUP UTILITY
<F9>	Load optimal default values for all the settings
<F10>	Save changes and exit the SETUP UTILITY
<F12>	Print screen
<ESC>	Jump to the Exit Screen or exit the current screen

4.4 Main Screen

When you enter the UEFI SETUP UTILITY, the Main screen will appear and display the system overview.

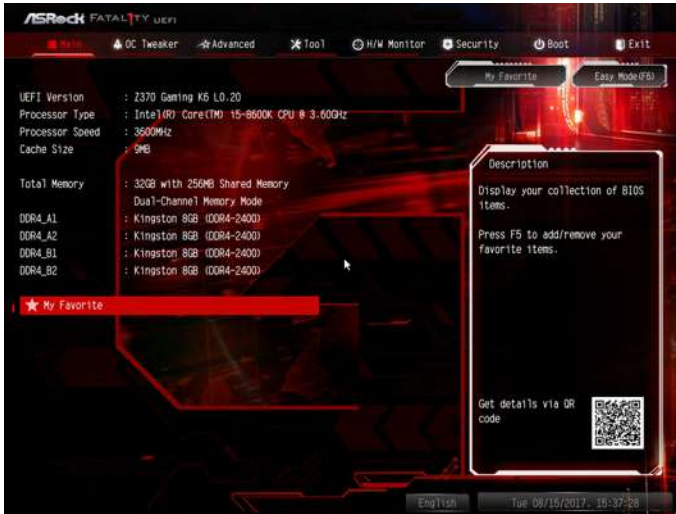

My Favorite

Display your collection of BIOS items. Press F5 to add/remove your favorite items.

4.5 OC Tweaker Screen

In the OC Tweaker screen, you can set up overclocking features.



Because the UEFI software is constantly being updated, the following UEFI setup screens and descriptions are for reference purpose only, and they may not exactly match what you see on your screen.

Advanced Turbo

You can use this option to increase your system performance. This option appears only when your CPU supports this function. This option appears only when you adopt K-Series CPU.

Load Optimized CPU OC Setting

You can use this option to load optimized CPU overclocking setting. Please note that overclocking may cause damage to your CPU and motherboard. It should be done at your own risk and expense.

Load Optimized GPU OC Setting

You can use this option to load optimized GPU overclocking setting. Please note that overclocking may cause damage to your GPU and motherboard. It should be done at your own risk and expense. This option appears only when you adopt K-Series CPU.

CPU Configuration

Multi Core Enhancement

Improve the system's performance by forcing the CPU to perform the highest frequency on all CPU cores simultaneously. Disable to reduce power consumption .

CPU Ratio

The CPU speed is determined by the CPU Ratio multiplied with the BCLK. Increasing the CPU Ratio will increase the internal CPU clock speed without affecting the clock speed of other components.

CPU Cache Ratio

The CPU Internal Bus Speed Ratio. The maximum should be the same as the CPU Ratio.

Minimum CPU Cache Ratio

Set the minimum CPU Internal Bus Speed Ratio.

BCLK Frequency

The CPU speed is determined by the CPU Ratio multiplied with the BCLK. Increasing the BCLK will increase the internal CPU clock speed but also affect the clock speed of other components.

Spread Spectrum

Enable Spread Spectrum to reduce electromagnetic interference for passing EMI tests. Disable to achieve higher clock speeds when overclocking.

CPU BCLK Amplitude

Configure the CPU BCLK Amplitude.

CPU Slew Rate

Configure the CPU Slew Rate.

CPU PLL ORT

Configure the CPU PLL ORT.

Divider

Configure the BCLK divider.

Boot Performance Mode

Default is Max Non-Turbo performance mode. It will keep cpu Flex-ratio till OS

handoff. Max Battery mode will set CPU ratio as x8 till OS handoff. This option is suggested for BCLK overclocking.

Reliability Stress Restrictor

Disable or Enable Reliability Stress Restrictor feature.

FCLK Frequency

Configure the FCLK Frequency.

AVX Ratio Offset

AVX Ratio Offset specifies a negative offset from the CPU Ratio for AVX workloads. AVX is a more stressful workload that lowers the AVX ratio to ensure maximum possible ratio for SSE workloads.

BCLK Aware Adaptive Voltage

BCLK Aware Adaptive Voltage enable/disable. When enabled, pcode will be aware of the BCLK frequency when calculating the CPU V/F curves. This is ideal for BCLK OC to avoid high voltage overrides.

Ring to Core Ratio Offset

Disable Ring to Core Ratio Offset so the ring and core can run at the same frequency.

Intel SpeedStep Technology

Intel SpeedStep technology allows processors to switch between multiple frequencies and voltage points for better power saving and heat dissipation.

Intel Turbo Boost Technology

Intel Turbo Boost Technology enables the processor to run above its base operating frequency when the operating system requests the highest performance state.

Intel Speed Shift Technology

Enable/Disable Intel Speed Shift Technology support. Enabling will expose the CPPC v2 interface to allow for hardware controlled P-states.

Long Duration Power Limit

Configure Package Power Limit 1 in watts. When the limit is exceeded, the CPU ratio will be lowered after a period of time. A lower limit can protect the CPU and save power, while a higher limit may improve performance.

Long Duration Maintained

Configure the period of time until the CPU ratio is lowered when the Long Duration Power Limit is exceeded.

Short Duration Power Limit

Configure Package Power Limit 2 in watts. When the limit is exceeded, the CPU ratio will be lowered immediately. A lower limit can protect the CPU and save power, while a higher limit may improve performance.

CPU Core Current Limit

Configure the current limit of the CPU core. A lower limit can protect the CPU and save power, while a higher limit may improve performance.

GT Slice Current Limit

Configure the current limit of the GT slice. A lower limit can protect the CPU and save power, while a higher limit may improve performance.

GT Frequency

Configure the frequency of the integrated GPU.

DRAM Configuration

DRAM Tweaker

Fine tune the DRAM settings by leaving marks in checkboxes. Click OK to confirm and apply your new settings.

DRAM Timing Configuration

Load XMP Setting

Load XMP settings to overclock the memory and perform beyond standard specifications.

BCLK Frequency

The CPU speed is determined by the CPU Ratio multiplied with the BCLK. Increasing the BCLK will increase the internal CPU clock speed but also affect the clock speed of other components.

DRAM Frequency Clock

Select Auto for optimized settings.

DRAM Frequency

If [Auto] is selected, the motherboard will detect the memory module(s) inserted and assign the appropriate frequency automatically.

Primary Timing

CAS# Latency (tCL)

The time between sending a column address to the memory and the beginning of the data in response.

RAS# to CAS# Delay and Row Precharge (tRCDtRP)

RAS# to CAS# Delay: The number of clock cycles required between the opening of a row of memory and accessing columns within it.

Row Precharge: The number of clock cycles required between the issuing of the precharge command and opening the next row.

RAS# Active Time (tRAS)

The number of clock cycles required between a bank active command and issuing the precharge command.

Command Rate (CR)

The delay between when a memory chip is selected and when the first active command can be issued.

Secondary Timing

Write Recovery Time (tWR)

The amount of delay that must elapse after the completion of a valid write operation, before an active bank can be precharged.

Refresh Cycle Time (tRFC)

The number of clocks from a Refresh command until the first Activate command to the same rank.

RAS to RAS Delay (tRRD_L)

The number of clocks between two rows activated in different banks of the same rank.

RAS to RAS Delay (tRRD_S)

The number of clocks between two rows activated in different banks of the same rank.

Write to Read Delay (tWTR_L)

The number of clocks between the last valid write operation and the next read command to the same internal bank.

Write to Read Delay (tWTR_S)

The number of clocks between the last valid write operation and the next read command to the same internal bank.

Read to Precharge (tRTP)

The number of clocks that are inserted between a read command to a row pre-charge command to the same rank.

Four Activate Window (tFAW)

The time window in which four activates are allowed the same rank.

CAS Write Latency (tCWL)

Configure CAS Write Latency.

Third Timing**tREFI**

Configure refresh cycles at an average periodic interval.

tCKE

Configure the period of time the DDR4 initiates a minimum of one refresh command internally once it enters Self-Refresh mode.

tRDRD_sg

Configure between module read to read delay.

tRDRD_dg

Configure between module read to read delay.

tRDRD_dr

Configure between module read to read delay.

tRDRD_dd

Configure between module read to read delay.

tRDWR_sg

Configure between module read to write delay.

tRDWR_dg

Configure between module read to write delay.

tRDWR_dr

Configure between module read to write delay.

tRDWR_dd

Configure between module read to write delay.

tWRRD_sg

Configure between module write to read delay.

tWRRD_dg

Configure between module write to read delay.

tWRRD_dr

Configure between module write to read delay.

tWRRD_dd

Configure between module write to read delay.

tWRWR_sg

Configure between module write to write delay.

tWRWR_dg

Configure between module write to write delay.

tWRWR_dr

Configure between module write to write delay.

tWRWR_dd

Configure between module write to write delay.

Fourth Timing

RTL Init Value

Configure round trip latency init value for round trip latency training.

IO-L Init Value

Configure IO latency init value for IO latency training.

RTL (CH A)

Configure round trip latency for channel A.

RTL (CH B)

Configure round trip latency for channel B.

IO-L (CH A)

Configure IO latency for channel A.

IO-L (CH B)

Configure IO latency for channel B.

IO-L Offset (CH A)

Configure IO latency offset for channel A.

IO-L Offset (CH B)

Configure IO latency offset for channel B.

RFR Delay (CH A)

Configure RFR Delay for Channel A.

RFR Delay (CH B)

Configure RFR Delay for Channel B.

Advanced Setting**ODT WR (CH A)**

Configure the memory on die termination resistors' WR for channel A.

ODT WR (CH B)

Configure the memory on die termination resistors' WR for channel B.

ODT PARK (CH A)

Configure the memory on die termination resistors' PARK for channel A.

ODT PARK (CH B)

Configure the memory on die termination resistors' PARK for channel B.

ODT NOM (CH A)

Use this to change ODT (CH A) Auto/Manual settings. The default is [Auto].

ODT NOM (CH B)

Use this to change ODT (CH B) Auto/Manual settings. The default is [Auto].

Dll Bandwidth 0

Configure the Dll Bandwidth 0.

Dll Bandwidth 1

Configure the Dll Bandwidth 1.

Dll Bandwidth 2

Configure the Dll Bandwidth 2.

Dll Bandwidth 3

Configure the Dll Bandwidth 3.

Command Tristate

Configure the Command Tristate Support.

Realtime Memory Timing

Configure the realtime memory timings.

[Enabled] The system will allow performing realtime memory timing changes after MRC_DONE.

MRC Fast Boot

Enable Memory Fast Boot to skip DRAM memory training for booting faster.

Voltage Configuration

CPU Core/Cache Voltage

Configure the voltage for the CPU Core/Cache.

CPU Load-Line Calibration

CPU Load-Line Calibration helps prevent CPU voltage droop when the system is under heavy load.

GT Core/Cache Voltage

Configure the voltage for the CPU Core/Cache.

GT Load-Line Calibration

GPU Load-Line Calibration helps prevent GPU voltage droop when the system is under heavy load.

DRAM Voltage

Use this to configure DRAM Voltage. The default value is [Auto].

DRAM Activating Power Supply

Configure the voltage for the DRAM Activating Power Supply.

PCH +1.0 Voltage

Configure the chipset voltage (1.0V).

VCCIO Voltage

Configure the voltage for the VCCIO.

VCCST Voltage

Configure the voltage for the VCCST.

VCCSA Voltage

Configure the voltage for the VCCSA.

VCCPLL Voltage

Configure the voltage for the VCCPLL.

CPU Internal PLL Voltage

Default is 0.900V. Each step is 0.015V. Adding 9- 15 steps will helps CPU PLL to lock internal clock during High frequency under Ln2 cooling. For example: 1.020V - 1.125V will be proper value. But the voltage level will be different on each processor. User has to find the best value for your own processor. CPU Vcore Voltage must higher than CPU Internal PLL Voltage, or your processor will hang.

GT PLL Voltage

Default is 0.900V. Each step is 0.015V. Adding 9 -15 steps will help CPU PLL to lock internal clock during High frequency under Ln2 cooling. For example: 1.020V - 1.125V will be proper value. Bu the voltage level will be different on each processor. User has to find the best value for user's own processor.

Ring PLL Voltage

Default is 0.900V. Each step is 0.015V. Adding 9 -15 steps will help CPU PLL to lock internal clock during High frequency under Ln2 cooling. For example: 1.020V - 1.125V will be proper value. Bu the voltage level will be different on each processor. User has to find the best value for user's own processor.

System Agent PLL Voltage

Default is 0.900V. Each step is 0.015V. Adding 9 -15 steps will help CPU PLL to lock internal clock during High frequency under Ln2 cooling. For example: 1.020V - 1.125V will be proper value. Bu the voltage level will be different on each processor. User has to find the best value for user's own processor.

Memory Controller PLL Voltage

Default is 0.900V. Each step is 0.015V. Adding 9 -15 steps will help CPU PLL to lock internal clock during High frequency under Ln2 cooling. For example: 1.020V - 1.125V will be proper value. Bu the voltage level will be different on each processor. User has to find the best value for user's own processor.

Save User Default

Type a profile name and press enter to save your settings as user default.

Load User Default

Load previously saved user defaults.

Save User UEFI Setup Profile to Disk

Save current UEFI settings as an user default profile to disk.

Load User UEFI Setup Profile to Disk

Load previously saved user defaults from the disk.

4.6 Advanced Screen

In this section, you may set the configurations for the following items: CPU Configuration, Chipset Configuration, Storage Configuration, Intel(R) Thunderbolt, Super IO Configuration, ACPI Configuration, USB Configuration and Trusted Computing.



Setting wrong values in this section may cause the system to malfunction.

UEFI Configuration

UEFI Setup Style

Select the default mode when entering the UEFI setup utility.

Active Page on Entry

Select the default page when entering the UEFI setup utility.

Full HD UEFI

When [Auto] is selected, the resolution will be set to 1920 x 1080 if the monitor supports Full HD resolution. If the monitor does not support Full HD resolution, then the resolution will be set to 1024 x 768. When [Disable] is selected, the resolution will be set to 1024 x 768 directly.

4.6.1 CPU Configuration



Active Processor Cores

Select the number of cores to enable in each processor package.

CPU C States Support

Enable CPU C States Support for power saving. It is recommended to keep C3, C6 and C7 all enabled for better power saving.

Enhanced Halt State (C1E)

Enable Enhanced Halt State (C1E) for lower power consumption.

CPU C3 State Support

Enable C3 sleep state for lower power consumption.

CPU C6 State Support

Enable C6 sleep state for lower power consumption.

CPU C7 State Support

Enable C7 sleep state for lower power consumption.

Package C State Support

Enable CPU, PCIe, Memory, Graphics C State Support for power saving.

CFG Lock

This item allows you to disable or enable the CFG Lock.

CPU Thermal Throttling

Enable CPU internal thermal control mechanisms to keep the CPU from overheating.

Intel Virtualization Technology

Intel Virtualization Technology allows a platform to run multiple operating systems and applications in independent partitions, so that one computer system can function as multiple virtual systems.

Hardware Prefetcher

Automatically prefetch data and code for the processor. Enable for better performance.

Adjacent Cache Line Prefetch

Automatically prefetch the subsequent cache line while retrieving the currently requested cache line. Enable for better performance.

Software Guard Extensions (SGX)

Use this item to enable or disable Software Controlled Software Guard Extensions (SGX).

4.6.2 Chipset Configuration



Primary Graphics Adapter

Select a primary VGA.

Top of Lower Usable Dram

Set the maximum value of TOLUD. Set this item to Dynamic to allow TOLUD to adjust automatically based on the largest MMIO length of the installed graphic controller.

Above 4G Decoding

Enable or disable 64bit capable Devices to be decoded in Above 4G Address Space (only if the system supports 64 bit PCI decoding).

VT-d

Intel® Virtualization Technology for Directed I/O helps your virtual machine monitor better utilize hardware by improving application compatibility and reliability, and providing additional levels of manageability, security, isolation, and I/O performance.

PCIE1 Link Speed

Select the link speed for PCIE1.

PCIE2 Link Speed

Select the link speed for PCIE2.

PCIe3 Link Speed

Select the link speed for PCIe3.

PCIe4 Link Speed

Select the link speed for PCIe4.

PCIe5 Link Speed

Select the link speed for PCIe5.

PCIe6 Link Speed

Select the link speed for PCIe6.

PCI Express Native Control

Select Enable for enhanced PCI Express power saving in OS.

PCIe ASPM Support

This option enables/disables the ASPM support for all CPU downstream devices.

PCH PCIe ASPM Support

This option enables/disables the ASPM support for all PCH PCIe devices.

DMI ASPM Support

This option enables/disables the control of ASPM on CPU side of the DMI Link.

PCH DMI ASPM Support

This option enables/disables the ASPM support for all PCH DMI devices.

IOAPIC 24-119 Entries

Enables/Disables IOAPIC 24-119 Entries. IRQ24-119 may be used by PCH devices. Disabling those interrupts may cause certain devices failure.

Share Memory

Configure the size of memory that is allocated to the integrated graphics processor when the system boots up.

IGPU Multi-Monitor

Select disable to disable the integrated graphics when an external graphics card is installed. Select enable to keep the integrated graphics enabled at all times.

Inte(R) Ethernet Connection I219-V

Enable or disable the onboard network interface controller (Intel® I219V).

Inte(R) Ethernet Controller I211

Enable or disable the onboard network interface controller (Intel® I211AT).

Onboard HD Audio

Enable/disable onboard HD audio. Set to Auto to enable onboard HD audio and automatically disable it when a sound card is installed.

Front Panel

Enable/disable front panel HD audio.

Onboard HDMI HD Audio

Enable audio for the onboard digital outputs.

WAN Radio

Enable/disable the WiFi module's connectivity.

Deep Sleep

Configure deep sleep mode for power saving when the computer is shut down.

Restore on AC/Power Loss

Select the power state after a power failure. If [Power Off] is selected, the power will remain off when the power recovers. If [Power On] is selected, the system will start to boot up when the power recovers.

Turn On LED in S5

Turn on/off the LED in the ACPI S5 state.

4.6.3 Storage Configuration

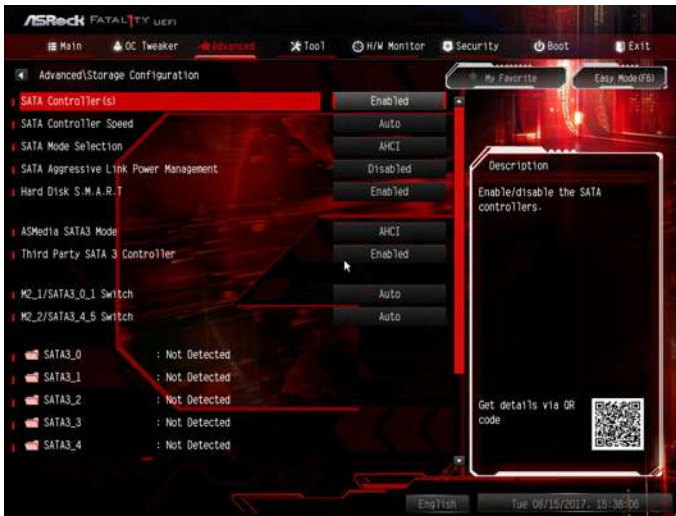

SATA Controller(s)

Enable/disable the SATA controllers.

SATA Controller Speed

Indicates the maximum speed the SATA controller can support.

SATA Mode Selection

[AHCI] Supports new features that improve performance.

[Intel RST Premium (RAID)] Combine multiple disk drives into a logical unit.

SATA Aggressive Link Power Management

SATA Aggressive Link Power Management allows SATA devices to enter a low power state during periods of inactivity to save power. It is only supported by AHCI mode.

Hard Disk S.M.A.R.T.

S.M.A.R.T stands for Self-Monitoring, Analysis, and Reporting Technology. It is a monitoring system for computer hard disk drives to detect and report on various indicators of reliability.

ASMedia SATA3 Mode

[AHCI] Supports new features that improve performance.

Third Party SATA 3 Controller

Enable or disable the third party SATA3 controller.

M2_1/ SATA3_0_1 Switch

[Auto] M2_1/SATA3_0_1 auto switch

[Force_SATA] Switch to SATA3_0_1

[Force_M2_1] Switch to M2_1

M2_2/ SATA3_4_5 Switch

[Auto] M2_2/SATA3_4_5 auto switch

[Force_SATA] Switch to SATA3_4_5

[Force_M2_1] Switch to M2_2

4.6.4 Intel® Thunderbolt



Intel® Thunderbolt Technology

Enable or disable the Intel® Thunderbolt™ function.

Security Level

Allows you to choose a security level for the Thunderbolt ports.

AR AIC Support

Enable or disable to support AR AIC card.

TBT Host Router

Enable the host router based on ports available.

4.6.5 Super IO Configuration

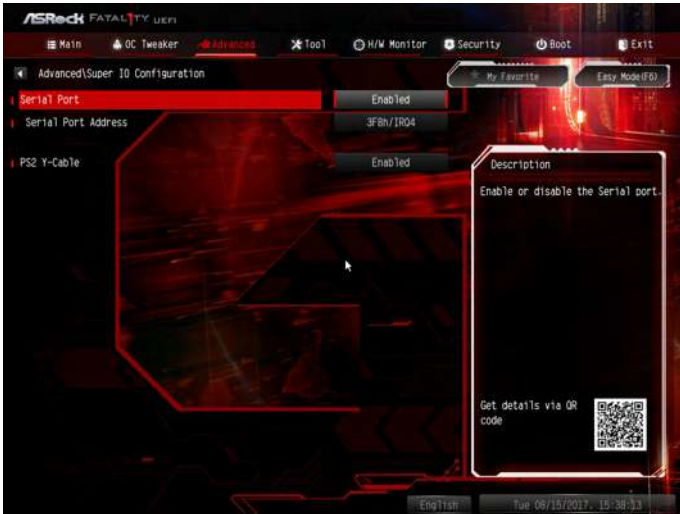

Serial Port

Enable or disable the Serial port.

Serial Port Address

Select the address of the Serial port.

PS2 Y-Cable

Enable the PS2 Y-Cable or set this option to Auto.

4.6.6 ACPI Configuration



Suspend to RAM

Select disable for ACPI suspend type S1. It is recommended to select auto for ACPI S3 power saving.

ACPI HEPT Table

Enable the High Precision Event Timer for better performance.

PS/2 Keyboard Power On

Allow the system to be waked up by a PS/2 Keyboard.

PCIe/PCI Devices Power On

Allow the system to be waked up by a PCIe/PCI device and enable wake on LAN.

I219 LAN Power On

Allow the system to be waked up by I219 LAN.

Ring-In Power On

Allow the system to be waked up by onboard COM port modem Ring-In signals.

RTC Alarm Power On

Allow the system to be waked up by the real time clock alarm. Set it to By OS to let it be handled by your operating system.

USB Keyboard/Remote Power On

Allow the system to be waked up by an USB keyboard or remote controller.

USB Mouse Power On

Allow the system to be waked up by an USB mouse.

4.6.7 USB Configuration

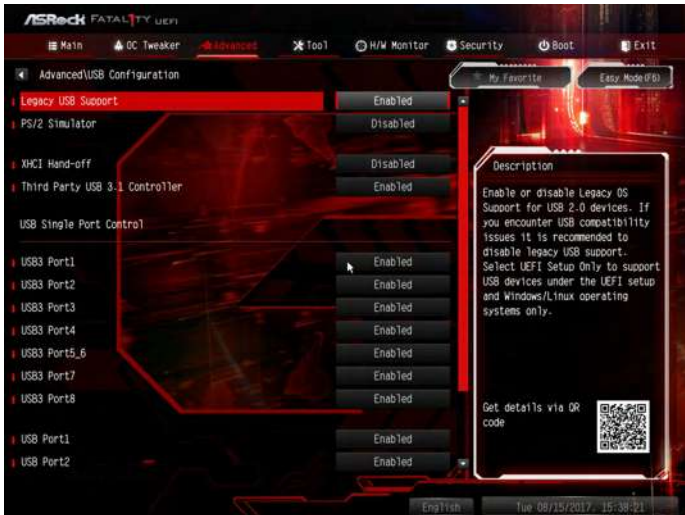

Legacy USB Support

Enable or disable Legacy OS Support for USB 2.0 devices. If you encounter USB compatibility issues it is recommended to disable legacy USB support. Select UEFI Setup Only to support USB devices under the UEFI setup and Windows/Linux operating systems only.

PS/2 Simulator

Enable the support of I/O port 60h/64h emulation. This should be enabled for the complete USB keyboard legacy support for non-USB aware OSes.

XHCI Hand-off

This is a workaround for OSes without XHCI hand-off support. The XHCI ownership change should be claimed by XHCI driver.

Third Party USB 3.1 Controller

Enable or disable all of the USB 3.1 Gen2 ports controlled by Third Party chips.

4.6.8 Trusted Computing



Security Device Support

Enable or disable BIOS support for security device.

4.7 Tools

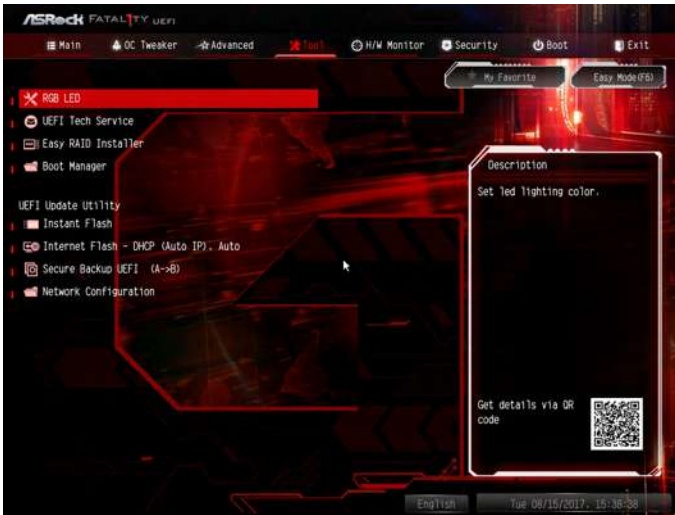

RGB LED

RGB LED and header allows users to connect LED strip and create their unique PC style easily.

UEFI Tech Service

Contact ASRock Tech Service if you are having trouble with your PC. Please setup network configuration before using UEFI Tech Service.

Easy RAID Installer

Easy RAID Installer helps you to copy the RAID driver from the support CD to your USB storage device. After copying the drivers please change the SATA mode to RAID, then you can start installing the operating system in RAID mode.

Boot Manager

Boot Manager is specifically designed for the dual OS platform/multi-OS platform users to easily customize and manage the boot menu.

*Please connect more than one boot devices to use this tool.



Boot Manager

Enable/disable the Boot Manager.

Boot Manager Timeout

Enable/disable the Boot Manager Timeout.

Timeout Seconds

Configure the number of seconds to wait for the Boot Manager.

Instant Flash

Save UEFI files in your USB storage device and run Instant Flash to update your UEFI.

Internet Flash - DHCP (Auto IP), Auto

ASRock Internet Flash downloads and updates the latest UEFI firmware version from our servers for you. Please setup network configuration before using Internet Flash.

*For BIOS backup and recovery purpose, it is recommended to plug in your USB pen drive before using this function.

Secure Backup UEFI

Whenever one of the ROM images are outdated or corrupted, switch to the other flash ROM and execute Secure Backup UEFI to duplicate the current working ROM image to the secondary flash ROM.



This motherboard has two BIOS chips, an active BIOS (BIOS_A) and a backup BIOS (BIOS_B), which enhances the safety and stability of your system. Use "Secure Backup UEFI" to duplicate a working copy of the BIOS files to the active BIOS to ensure normal system operation. Normally, the system will work on the active BIOS. However if the active BIOS is corrupted or damaged, after several failed boot attempts, the backup BIOS will take over. For safety issues, users are not able to update the backup BIOS manually. Users may refer to the BIOS LEDs (BIOS_A_LED or BIOS_B_LED) to identify which BIOS is currently activated.

Network Configuration

Use this to configure internet connection settings for Internet Flash.



Internet Setting

Enable or disable sound effects in the setup utility.

UEFI Download Server

Select a server to download the UEFI firmware.

4.8 Hardware Health Event Monitoring Screen

This section allows you to monitor the status of the hardware on your system, including the parameters of the CPU temperature, motherboard temperature, fan speed and voltage.



Fan Tuning

Measure Fan Min Duty Cycle.

Fan-Tastic Tuning

Select a fan mode for CPU Fans 1&2, or choose Customize to set 5 CPU temperatures and assign a respective fan speed for each temperature.

CPU Fan 1 Setting

Select a fan mode for CPU Fans 1, or choose Customize to set 5 CPU temperatures and assign a respective fan speed for each temperature.

CPU Fan Step Up

Set the value of CPU Fan Step Up.

CPU Fan Step Down

Set the value of CPU Fan Step Down.

CPU_OPT / W_Pump Switch

Select CPU Optional or Water Pump mode.

CPU Optional Fan Control Mode

Select PWM mode or DC mode for CPU Optional fan.

CPU Optional Fan Setting

Select a fan mode for CPU Optional fan, or choose Customize to set 5 CPU temperatures and assign a respective fan speed for each temperature.

CPU Optional Fan Temp Source

Select a fan temperature source for CPU Optional fan.

CPU Optional Fan Step Up

Set the value of CPU Optional fan Step Up.

CPU Optional Fan Step Down

Set the value of CPU Optional fan Step Down.

Chassis Fan 1 Setting

Select a fan mode for Chassis Fan 1, or choose Customize to set 5 CPU temperatures and assign a respective fan speed for each temperature.

Chassis Fan 1 Temp Source

Select a fan temperature source for Chassis Fan 1.

Chassis Fan 1 Step Up

Set the value of Chassis Fan 1 Step Up.

Chassis Fan 1 Step Down

Set the value of Chassis Fan 1 Step Down.

Chassis Fan 2 Setting

Select a fan mode for Chassis Fan 2, or choose Customize to set 5 CPU temperatures and assign a respective fan speed for each temperature.

Chassis Fan 2 Temp Source

Select a fan temperature source for Chassis Fan 2.

Chassis Fan 2 Step Up

Set the value of Chassis Fan 2 Step Up.

Chassis Fan 2 Step Down

Set the value of Chassis Fan 2 Step Down.

CHA_FAN3 / W_Pump Switch

Select CHA_FAN3/CPU Optional or Water Pump mode.

Chassis Fan 3 Control Mode

Select PWM mode or DC mode for Chassis Fan 3.

Chassis Fan 3 Setting

Select a fan mode for Chassis Fan 3, or choose Customize to set 5 CPU temperatures and assign a respective fan speed for each temperature.

Chassis Fan 3 Temp Source

Select a fan temperature source for Chassis Fan 3.

Chassis Fan 3 Step Up

Set the value of Chassis Fan 3 Step Up.

Chassis Fan 3 Step Down

Set the value of Chassis Fan 3 Step Down.

Over Temperature Protection

When Over Temperature Protection is enabled, the system automatically shuts down when the motherboard is overheated.

4.9 Security Screen

In this section you may set or change the supervisor/user password for the system. You may also clear the user password.

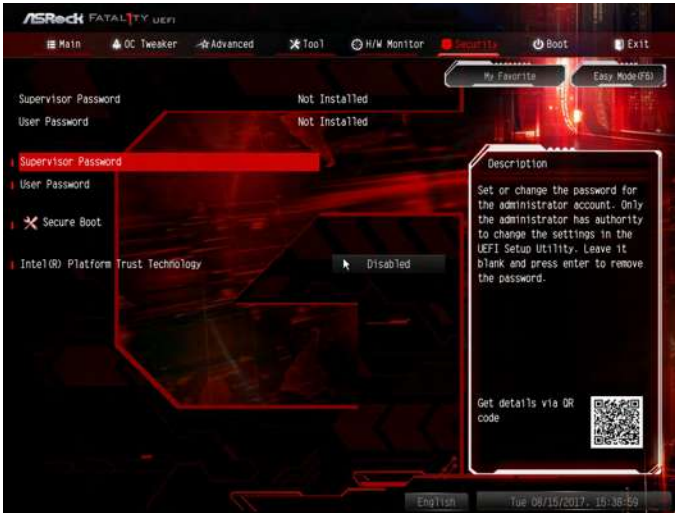

Supervisor Password

Set or change the password for the administrator account. Only the administrator has authority to change the settings in the UEFI Setup Utility. Leave it blank and press enter to remove the password.

User Password

Set or change the password for the user account. Users are unable to change the settings in the UEFI Setup Utility. Leave it blank and press enter to remove the password.

Secure Boot

Use this item to enable or disable support for Secure Boot.

Intel(R) Platform Trust Technology

Enable/disable Intel PTT in ME. Disable this option to use discrete TPM Module.

4.10 Boot Screen

This section displays the available devices on your system for you to configure the boot settings and the boot priority.



Fast Boot

Fast Boot minimizes your computer's boot time. In fast mode you may not boot from an USB storage device. The VBIOS must support UEFI GOP if you are using an external graphics card. Please notice that Ultra Fast mode will boot so fast that the only way to enter this UEFI Setup Utility is to Clear CMOS or run the Restart to UEFI utility in Windows.

Boot From Onboard LAN

Allow the system to be waked up by the onboard LAN.

Setup Prompt Timeout

Configure the number of seconds to wait for the setup hot key.

Bootup Num-Lock

Select whether Num Lock should be turned on or off when the system boots up.

Boot Beep

Select whether the Boot Beep should be turned on or off when the system boots up. Please note that a buzzer is needed.

Full Screen Logo

Enable to display the boot logo or disable to show normal POST messages.

AddOn ROM Display

Enable AddOn ROM Display to see the AddOn ROM messages or configure the AddOn ROM if you've enabled Full Screen Logo. Disable for faster boot speed.

Boot Failure Message

If the computer fails to boot for a number of times the system automatically restores the default settings.

CSM (Compatibility Support Module)



CSM

Enable to launch the Compatibility Support Module. Please do not disable unless you're running a WHCK test.

Launch PXE OpROM Policy

Select UEFI only to run those that support UEFI option ROM only. Select Legacy only to run those that support legacy option ROM only. Select Do not launch to not execute both legacy and UEFI option ROM.

Launch Storage OpROM Policy

Select **UEFI only** to run those that support UEFI option ROM only. Select **Legacy only** to run those that support legacy option ROM only. Select **Do not launch** to not execute both legacy and UEFI option ROM.

Launch Video OpROM Policy

Select **UEFI only** to run those that support UEFI option ROM only. Select **Legacy only** to run those that support legacy option ROM only. Select **Do not launch** to not execute both legacy and UEFI option ROM.

4.11 Exit Screen



Save Changes and Exit

When you select this option the following message, “Save configuration changes and exit setup?” will pop out. Select [OK] to save changes and exit the UEFI SETUP UTILITY.

Discard Changes and Exit

When you select this option the following message, “Discard changes and exit setup?” will pop out. Select [OK] to exit the UEFI SETUP UTILITY without saving any changes.

Discard Changes

When you select this option the following message, “Discard changes?” will pop out. Select [OK] to discard all changes.

Load UEFI Defaults

Load UEFI default values for all options. The F9 key can be used for this operation.

Launch EFI Shell from filesystem device

Copy shellx64.efi to the root directory to launch EFI Shell.

Contact Information

If you need to contact ASRock or want to know more about ASRock, you're welcome to visit ASRock's website at <http://www.asrock.com>; or you may contact your dealer for further information. For technical questions, please submit a support request form at <http://www.asrock.com/support/tsd.asp>

ASRock Incorporation

2F., No.37, Sec. 2, Jhongyang S. Rd., Beitou District,

Taipei City 112, Taiwan (R.O.C.)

ASRock EUROPE B.V.

Bijsterhuizen 11-11

6546 AR Nijmegen

The Netherlands

Phone: +31-24-345-44-33

Fax: +31-24-345-44-38

ASRock America, Inc.

13848 Magnolia Ave, Chino, CA91710

U.S.A.

Phone: +1-909-590-8308

Fax: +1-909-590-1026

DECLARATION OF CONFORMITY

Per FCC Part 2 Section 2.1077(a)



Responsible Party Name: ASRock Incorporation

Address: 13848 Magnolia Ave, Chino, CA91710

Phone/Fax No: +1-909-590-8308/+1-909-590-1026

hereby declares that the product

Product Name : Motherboard

Model Number : Fatal1ty Z370 Gaming K6 Series

Conforms to the following specifications:

FCC Part 15, Subpart B, Unintentional Radiators

Supplementary Information:

This device complies with part 15 of the FCC Rules. Operation is subject to the following two conditions: (1) This device may not cause harmful interference, and (2) this device must accept any interference received, including interference that may cause undesired operation.

Representative Person's Name: James

Signature:

A handwritten signature in black ink, appearing to read 'James', written over a horizontal line.

Date : May 12, 2017

EU Declaration of Conformity



For the following equipment:

Motherboard

(Product Name)

Fatal1ty Z370 Gaming K6 Series / ASRock

(Model Designation / Trade Name)

ASRock Incorporation

(Manufacturer Name)

2F., No.37, Sec. 2, Zhongyang S. Rd., Beitou District, Taipei City 112, Taiwan (R.O.C.)

(Manufacturer Address)

EMC —Directive 2014/30/EU (from April 20th, 2016)

EN 55022:2010/AC:2011 Class B

EN 55024:2010/A1:2015

EN 55032:2012+AC:2013 Class B

EN 61000-3-3:2013

EN 61000-3-2:2014

LVD —Directive 2014/35/EU (from April 20th, 2016)

EN 60950-1 : 2011+ A2: 2013

EN 60950-1 : 2006/A12: 2011

RoHS — Directive 2011/65/EU

CE marking

(EU conformity marking)



ASRock EUROPE B.V.

(Company Name)

Bijsterhuizen 1111 6546 AR Nijmegen The Netherlands

(Company Address)

Person responsible for making this declaration:

(Name, Surname)

A.V.P

(Position / Title)

September 15, 2017

(Date)

P/N: 15G062053001AK V1.1